

Mobrey MSP400RH and MSP900GH

Ultrasonic Liquid Level Transmitters



Mobrey MSP400RH and MSP900GH Ultrasonic Liquid Level Transmitters

⚠ WARNING

Read this manual before working with the product. For personal and system safety, and for optimum product performance, make sure you thoroughly understand the contents before installing, using, or maintaining this product.

⚠ CAUTION

The products described in this document are NOT designed for nuclear-qualified applications.

Using non-nuclear qualified products in applications that require nuclear-qualified hardware or products may cause inaccurate readings.

For information on nuclear-qualified products, contact your local Rosemount Measurement sales representative.

This device complies with part 15 of the FCC rules. Operation is subject to the following two conditions: (1) This device may not cause harmful interference, and (2) this device must accept any interference received, including interference that may cause undesired operation.

Table of Contents

Section 1: Introduction

1.1 Safety messages.....	1
1.2 Manual overview	2
1.3 Service and product support	2
1.4 Product recycling/disposal.....	2

Section 2: Transmitter Overview

2.1 Introduction to the transmitters.....	3
2.2 Theory of operation.....	3
2.3 Components of the transmitter	4
2.4 System architecture.....	4

Section 3: Installation

3.1 Safety messages.....	7
3.2 Considerations before installation	8
3.2.1 Safety considerations	8
3.3 Mechanical installation	9
3.3.1 Consider the liquid surface conditions.....	10
3.3.2 In-tank effects.....	10
3.3.3 Mounting the transmitter above the liquid surface.....	11
3.3.4 Open channel flow installations	13
3.4 Electrical installation	16
3.4.1 Connecting the cable(s) to the transmitter	16
3.4.2 Connecting the cable wires to the MSP400RH.....	17
3.4.3 Connecting the cable wires to the MSP900GH.....	18
3.4.4 Remote temperature sensor	19
3.4.5 Wiring to allow HART communications.....	19
3.4.6 Lightning / Surge protection and other loop devices	20

Section 4: Starting up

4.1 Overview	21
4.1.1 Display and push-buttons.....	21
4.1.2 Power up	22
4.1.3 Before programming.....	23

4.2	Programming	23
4.2.1	Overview	23
4.2.2	Selecting the duty	24
4.2.3	Selecting the units of measurement	25
4.2.4	Setting the correct bottom reference	26
4.2.5	Selecting a profile	27
4.2.6	Power Factor for the Flow Law	31
4.2.7	K-factor for the flow law	32
4.2.8	Maximum level entry	33
4.2.9	Maximum flow entry	34
4.2.10	Maximum contents (volume) entry	35
4.2.11	Setting the 4 mA point	36
4.2.12	Setting the 20 mA point	37
4.2.13	Setting the output damping	38
4.2.14	Selecting the alarm condition action	39
4.2.15	Setting the relay on and off points (MSP400RH)	40
4.2.16	Setting the 4 and 20 mA levels using ranging	41
4.3	Final checks	43
4.4	Power failure	43

Section 5: Service and Troubleshooting

5.1	Safety messages	45
5.2	Servicing	46
5.3	Diagnostics	46
5.3.1	General troubleshooting	46
5.3.2	Diagnostic data	46
5.3.3	Loop test	47
5.4	Engineering menu	49
5.4.1	Accessing the engineering menu	49
5.4.2	Setting the threshold	49
5.4.3	Setting lost echo time	50
5.4.4	Setting the dead band	51
5.4.5	Setting the frequency	52
5.4.6	Setting the pulse repetition frequency	53
5.4.7	Setting valid echo count	54
5.4.8	Setting Spike Rejection	55
5.4.9	Learn about echoes from false targets	56
5.4.10	Setting the ambient temperature	57

5.4.11	Temperature calibration.....	58
5.4.12	Loading factory default values.....	59
5.4.13	Changing the base units.....	60
5.5	False echoes under certain ambient operating conditions.....	61

Section A: Reference Data

A.1	Specifications	63
A.1.1	General	63
A.1.2	Measuring performance.....	63
A.1.3	Display and configuration	63
A.1.4	Electrical	64
A.1.5	Physical specifications.....	65
A.1.6	Mechanical	65
A.1.7	Measuring	65
A.1.8	Environment.....	66
A.2	Dimension drawings	68

Section B: Product Certifications

B.1	Safety messages.....	71
B.2	Approved manufacturing location	71
B.3	European directive information.....	72
B.4	Ordinary locations certification (MSP400RH only).....	72
B.4.1	American certification.....	72
B.5	Hazardous locations certifications (MSP900GH only).....	72
B.5.1	European certification.....	72

Section C: Integrated Display Menus

C.1	Main menu map	76
C.2	Diagnostics menu map	78
C.3	Engineering menu map.....	79

Appendix D: Mobrey MCU900 Series

D.1	Introduction	81
-----	--------------------	----

Appendix E: Field Communicator

E.1	Introduction	85
E.2	Safety messages.....	85

Appendix F: Configuring Using HART

F.1 Overview	89
F.2 Command parameters	90
F.2.1 Base units	90
F.2.2 Set as empty	91
F.2.3 Present depth	92
F.2.4 Learn false echo	93
F.2.5 Auto tank map	94
F.2.6 Simulation of PV	95
F.2.7 Restart device	96
F.2.8 Load defaults	97
F.2.9 Simulate current output	98
F.2.10 Trim 4 mA / Trim 20 mA	99
F.3 Configuration parameters	101
F.3.1 Message (P000)	101
F.3.2 Tag (P001)	102
F.3.3 Descriptor (P002)	102
F.3.4 Final assembly number (P004)	103
F.3.5 Serial number (P005)	104
F.3.6 Bottom reference (P010)	105
F.3.7 Upper blanking (P023)	107
F.3.8 Lower blanking (P063)	108
F.3.9 Distance offset (P060)	109
F.3.10 Level offset (P069)	110
F.3.11 Tank shape / non-linear profile (P011)	111
F.3.12 Contents (volume) measurement	112
F.3.13 Flow measurement	116
F.3.14 Primary variable units (P012)	120
F.3.15 Scale Factor / K-Factor (P013)	121
F.3.16 Profile height / Power factor (P014)	122
F.3.17 Profile points 1 to 10 (P030 to P039)	124
F.3.18 Upper range value (P015)	125
F.3.19 Lower range value (P016)	126
F.3.20 Damping (P020)	127
F.3.21 Setting-up relays on the MSP400RH	128
F.3.22 Relay 1 (P070 to P072)	128
F.3.23 Relay 2 (P073 to P075)	128

F.3.24	Lost echo delay (P021)	128
F.3.25	Lost echo action (P022)	130
F.3.26	Speed of sound (P024)	131
F.3.27	Temperature (P025)	132
F.3.28	Set threshold (P026)	133
F.3.29	Transmit power control (P040)	135
F.3.30	Pulse repeat (P041)	136
F.3.31	Echoes needed (P042)	136
F.3.32	Threshold 1 time (P043).....	137
F.3.33	Threshold 1 size (P048).....	138
F.3.34	Target pulses (P044)	139
F.3.35	Target frequency (P045).....	140
F.3.36	Spike rejection (P049).....	141
F.3.37	False echo data (P081 to P088)	142
F.3.38	Clear false echoes (P089)	143
F.3.39	Transducer material (P970)	144
F.3.40	Poll address (D951)	144
F.3.41	Maximum temperature (P046)	145
F.3.42	Minimum temperature (P047)	146
F.3.43	Date (P003).....	146
F.4	Monitoring and diagnostic parameters	147
F.4.1	Process value / Primary variable (PV) (D900)	147
F.4.2	Level / Secondary variable (SV) (D901)	148
F.4.3	Distance / Tertiary variable (TV) (D902)	149
F.4.4	Temperature / Fourth variable (FV) (D903).....	150
F.4.5	% of output current (D905)	151
F.4.6	Current output (D906)	152
F.4.7	Distance (D910).....	153
F.4.8	Echo size (D911).....	154
F.4.9	Echo success (D912)	155
F.4.10	Target echoes (D913)	156
F.4.11	Speed of sound (D914).....	157
F.4.12	Temperature for SoS calculation (D915).....	158
F.4.13	Frequency (D916)	159
F.4.14	Threshold in use (D917)	160
F.4.15	Pulses in use (D918)	161
F.4.16	Transmit power (D919)	162

F.4.17	Model code (D949)	163
F.4.18	Hardware rev. (D952)	163
F.4.19	Software revision (D953)	164
F.4.20	Manufacturer (D960)	165
F.4.21	Unique device ID (D961)	165
F.4.22	HART revision (D962)	166
F.4.23	Transmitter specific command rev. (D963)	167
F.4.24	Preambles (D964)	167
F.4.25	Transmitter flags (D965)	168
F.4.26	Primary variable trend.....	169

Section 1 Introduction

Safety messages	page 1
Manual overview	page 2
Service and product support	page 2
Product recycling/disposal	page 2

1.1 Safety messages

Procedures and instructions in this manual may require special precautions to ensure the safety of the personnel performing the operations. Information that raises potential safety issues is indicated by a caution symbol (⚠). The external hot surface symbol (🔥) is used when a surface is hot and care must be taken to avoid possible burns. If there is a risk of an electrical shock the (⚡) symbol is used. Refer to the safety messages listed at the beginning of each section before performing an operation preceded by this symbol.

⚠ WARNING

Failure to follow these installation guidelines could result in death or serious injury.

- Make sure only qualified personnel perform the installation.
- Use the equipment only as specified in this manual. Failure to do so may impair the protection provided by the equipment.

Explosions could result in death or serious injury.

- Verify that the operating environment of the transmitter is consistent with the appropriate hazardous locations certifications.
- Before connecting a HART[®]-based communicator in an explosive atmosphere, make sure the instruments in the loop are installed in accordance with intrinsically safe or non-incendive field wiring practices.

Electrical shock could cause death or serious injury.

- Use extreme caution when making contact with the leads and terminals.

⚠ WARNING

Any substitution of non-recognized parts may jeopardize safety. Repair, e.g. substitution of components etc., may also jeopardize safety and is under no circumstances allowed.

1.2 Manual overview

This manual provides installation, configuration, and maintenance information for the Mobrey MSP400RH and MSP900GH ultrasonic liquid level transmitters.

- Section 2: Transmitter Overview
- Section 3: Installation
- Section 4: Starting up
- Section 5: Service and Troubleshooting
- Appendix A: Reference Data
- Appendix B: Product Certifications
- Appendix C: Integrated Display Menus
- Appendix D: Mobrey MCU900 Series
- Appendix E: Field Communicator
- Appendix F: Configuring Using HART

1.3 Service and product support

For the latest support information, visit www.emersonprocess.com, and then select the Mobrey brand page. At the Mobrey page, click on the quick links Mobrey Service or Product Support.

CAUTION

Individuals who handle products exposed to a hazardous substance can avoid injury if they are informed of, and understand, the hazard. If the product being returned was exposed to a hazardous substance as defined by OSHA, a copy of the required Material Safety Data Sheet (MSDS) for each hazardous substance identified must be included with the returned goods.

1.4 Product recycling/disposal

Recycling of equipment and packaging should be taken into consideration. The product and packaging should be disposed of in accordance with local and national legislation.

Section 2 Transmitter Overview

Introduction to the transmitters	page 3
Theory of operation	page 3
Components of the transmitter	page 4
System architecture	page 4

2.1 Introduction to the transmitters

The Mobrey MSP400RH and Mobrey MSP900GH are 4–20 mA loop-powered transmitters, and are designed for liquid level measurement applications.

2.2 Theory of operation

The Mobrey MSP400RH and MSP900GH ultrasonic liquid level transmitters are mounted above a liquid and use ultrasonic pulses to continuously measure the distance to the liquid surface. The electronics calculate the distance to the liquid level using the time delay between transmitting and receiving signals (Figure 2-1).

When programmed with the bottom reference of the application – usually the bottom of a tank – the transmitter calculates the liquid depth (level), and outputs the result as a 4–20 mA signal and a digital HART® signal.

The MSP400RH and MSP900GH can also calculate contents volume or open channel flow, when programmed with further application information, and then outputs the result as a 4–20 mA signal and a digital HART signal.

Figure 2-1. Typical Application using Mobrey MSP400RH and MSP900GH transmitters

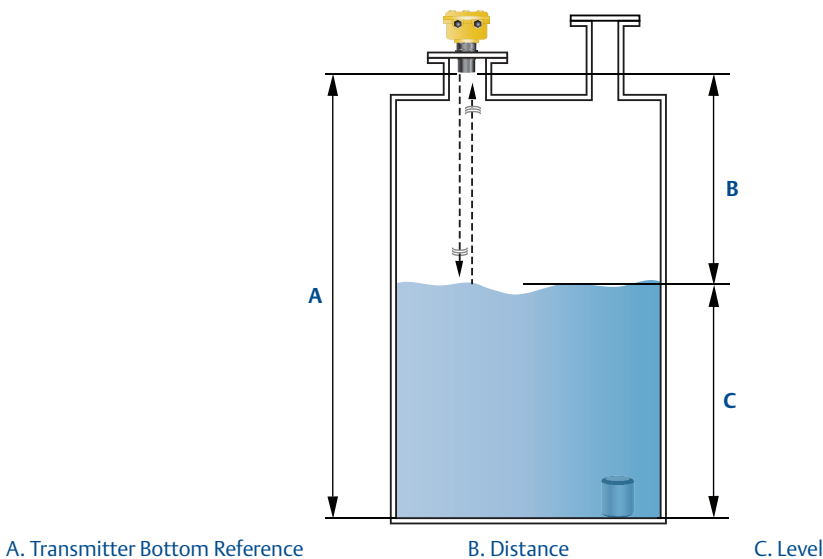

2.3 Components of the transmitter

The transmitter has a housing containing **advanced electronics** to generate ultrasonic pulses, process the resultant signals, and provide a 4–20mA and HART output.

Removing the lid reveals **terminals** to connect a cable (not supplied) for the signal output and an external power supply. An **LCD** inside the enclosure displays the selected measurement. Programming is achieved using **integral buttons** or by remote communication using HART.

Figure 2-2. Features of the MSP400RH and MSP900GH transmitters

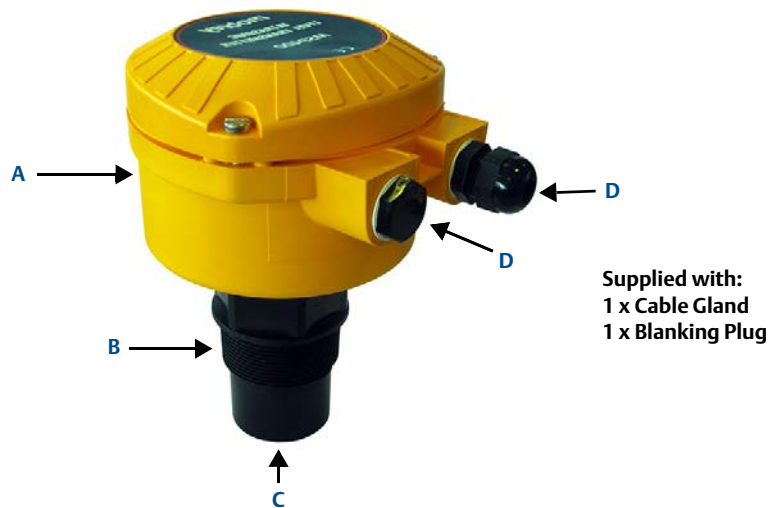

A. Electronics Housing
B. 2-in. Mounting Thread

C. Transmitter Face
D. M20 Conduit Threads

2.4 System architecture

The Mobrey MSP400RH and MSP900GH are two-wire, 24 Vdc loop-powered transmitters and can be connected to a direct current (dc) power source using two-core, shielded cable.

The output can be a 4–20 mA analog signal and a digital HART signal.

Note

- It is possible to use the multi-drop function with the HART protocol. In this case, communication is restricted to digital since the current is fixed to 4 mA.

Each transmitter can be configured locally using the membrane-buttons which are revealed after removing the housing cover. The transmitters can be configured remotely by using a Mobrey MCU900 Series control unit

A comprehensive specification for the Mobrey MSP400RH and MSP900GH is in the section “Specifications” on page 63.

Figure 2-3. System architecture

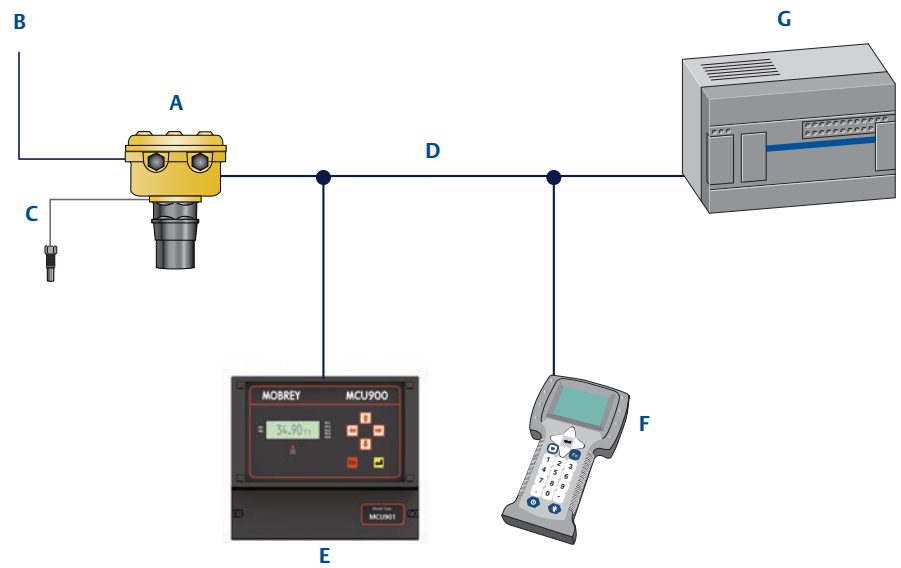

- A. Mobrey MSP Series Transmitter
- B. Two Relay Outputs (MSP400RH only)
- C. Mobrey Remote Temperature Sensor (Optional Accessory)
- D. 4–20 mA / HART Signals
- E. Mobrey MCU900 Series Control Unit
- F. Field Communicator
- G. Control System

Section 3 Installation

Safety messages	page 7
Considerations before installation	page 8
Mechanical installation	page 9
Electrical installation	page 16

3.1 Safety messages

Procedures and instructions in this manual may require special precautions to ensure the safety of the personnel performing the operations. Information that raises potential safety issues is indicated by a caution symbol (⚠). The external hot surface symbol (🔥) is used when a surface is hot and care must be taken to avoid possible burns. If there is a risk of an electrical shock the (⚡) symbol is used. Refer to the safety messages listed at the beginning of each section before performing an operation preceded by this symbol.

⚠ WARNING

Failure to follow these installation guidelines could result in death or serious injury

- Make sure only qualified personnel perform the installation.
- Use the equipment only as specified in this manual. Failure to do so may impair the protection provided by the equipment.

Explosions could result in death or serious injury

- Verify that the operating environment of the transmitter is consistent with the appropriate hazardous locations certifications.
- Before connecting a HART[®]-based communicator in an explosive atmosphere, make sure the instruments in the loop are installed in accordance with intrinsically safe or non-incendive field wiring practices.

Electrical shock could cause death or serious injury

- Use extreme caution when making contact with the leads and terminals.
-

⚠ WARNING

Any substitution of non-recognized parts may jeopardize safety. Repair, e.g. substitution of components etc., may also jeopardize safety and is under no circumstances allowed.

3.2 Considerations before installation

The Mobrey MSP400RH and MSP900GH transmitters can be used for level and contents volume measurements in open or closed tanks, or for open channel flow measurements.

The transmitter must be installed in a location where it is protected from ultraviolet radiation to prevent long term degradation of the plastics used e.g. shrouded from direct sunlight.

It is important to correctly position the transmitter for reliable ultrasonic level measurement. For maximum accuracy and stability of the level measurement reading, the transmitter should always be shrouded from direct sunlight and radiated heat.

The transmitter may be site-tuned to deal with most application conditions, but it is recommended that the following guidelines be adopted where relevant.

3.2.1 Safety considerations

Guidelines

1. Installation must be carried out by suitably trained personnel in accordance with the applicable code of practice.
2. If the equipment is likely to come into contact with *aggressive substances*, it is the responsibility of the user to take *suitable precautions* that prevent it from being adversely affected, thus ensuring that the type of protection is not compromised.

Aggressive substances are acidic liquids or gases that may attack metals or solvents that may affect polymeric materials.

Suitable precautions are regular checks as part of routine inspections, or establishing, from the material's datasheet, that it is resistant to specific chemicals.
3. The equipment must only be cleaned with a damp cloth.
4. The equipment is not intended to be repaired by the user and is to be replaced by an equivalent certified unit. Repairs should only be carried out by the manufacturer or approved repairer.
5. The transmitter is *double insulated*, and therefore Protective Earthing is not required. However, the cable shield/screen should be connected to a suitable ground (earth) at one end only (see “[Connecting the cable\(s\) to the transmitter](#)” on page 16).
6. Note that if the equipment is used in a manner not specified by the manufacturer, the protection afforded by the equipment may be impaired.
7. To ensure electro-magnetic compatibility in any European member state, it should not be installed in a residential area.

Note

- It is not advisable to mount the transmitter in close proximity to a source of electrical noise such as a variable-speed drive, or other high-powered electrical device.
-

3.3 Mechanical installation

Guidelines

1. Mount the transmitter above the liquid surface using the 2-inch thread provided, but not closer than 12 in. (0,3 m) to the surface. The transmitter does not detect any liquid surface closer than 12 in. (0,3 m) to the transmitter face. (See [“Mounting the transmitter above the liquid surface”](#) on page 11).
Optional flanges and bracket kits are available to help mounting. (See Rosemount Measurement product data sheet IP2045 for accessory part numbers.)
2. The transmitter should be mounted vertically to ensure a good echo from the liquid surface. The transmitter beam half angle of the is 6 degrees. (See [Figure 3-1](#) on page 10).
3. Obstructions in the tank, or well, may generate echoes which can be confused with the real liquid surface echo. Obstructions within the beam angle generate strong false echoes. Wherever possible, the transmitter should be positioned to avoid false echoes.
4. To avoid detecting unwanted objects in the tank or well, it is advisable to maintain a distance of at least 1.3 in. from the center line of the transmitter for every foot (11 cm per meter) range to the obstruction.
5. No false echoes are generated if the transmitter is located near the side of the tank or well, and the wall is smooth and free of protrusions. However, there will still be a reduction in the echo size. It is recommended that the transmitter be mounted no closer than 12 in. (0,3 m) to the wall to avoid a large reduction in the echo size.
6. If the transmitter is mounted in an enclosed tank with a domed top, avoid mounting the transmitter in the center of the tank roof because this could act as a parabolic reflector and create unwanted echoes.
7. Avoid applications where heavy condensation could form on the transmitter face.
8. If the transmitter is mounted in a stand-off or nozzle, the transmitter face should protrude at least 0.2 in. (5 mm) into the tank. If this is not possible, see [“Mounting the transmitter above the liquid surface”](#) on page 11).
9. If the transmitter is used in environments where direct sunlight can cause high surface temperatures on exposed surfaces, a sun-shade is recommended.
10. Check that the maximum liquid level will not enter the 12-in. (0,3 m) blanking zone of the transmitter.

Figure 3-1. Min And Max Distances From Tank Wall

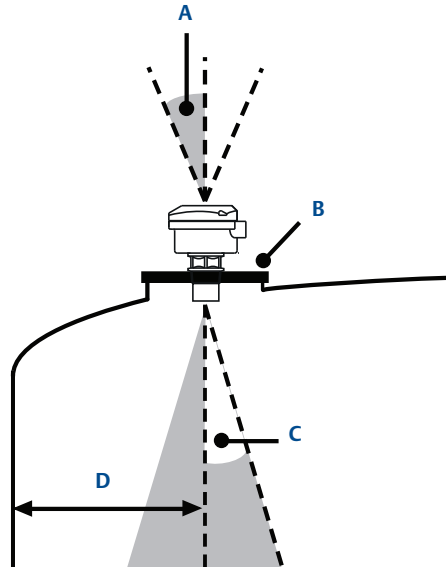

- A. Transmitter is mounted vertically (maximum deviation of 3°).
- B. Use a non-metallic fitting or flange.
- C. 6° beam half angle
- D. 1.3 in./ft. (11 cm/m). Minimum of 12 in. (0.3 m).

3.3.1 Consider the liquid surface conditions

Guidelines

1. Foaming liquids can reduce the size of the returned echo because foam is a poor ultrasonic reflector.

Mount an ultrasonic transmitter over an area of clear liquid, such as near the inlet to a tank or well. In extreme conditions, or where this is not possible, the transmitter may be mounted in a vented stilling tube provided that the inside measurement of the stilling tube is at least 4 in. (100 mm) and is smooth and free from joints or protrusions. It is important that the bottom of the stilling tube stays covered to prevent the ingress of foams.
2. Avoid mounting the transmitter directly over any inlet stream.

3.3.2 In-tank effects

Guidelines

1. Stirrers or agitators can cause a vortex. Mount the transmitter off-center of any vortex to maximize the return echo.
2. If stirrer blades become uncovered, they create echoes as they pass through the ultrasonic beam. The transmitter can learn to ignore these *false echoes* (see [page 56](#) or [page 93](#) for further information).

3. In tanks with rounded or conical bottoms, mount the transmitter off-center. If needed, a perforated reflector plate can be installed on the tank bottom directly under the transmitter center line to ensure a satisfactory return echo.
4. Avoid detecting pump casings, as the liquid falls away, by not mounting the transmitter directly above pumps. If this is not possible, fine-tuning of the transmitter on-site may be required.

3.3.3 Mounting the transmitter above the liquid surface

A 2-in. thread is provided to mount the transmitter. The thread form is either BSPT or NPT, and is *clearly marked* on the hexagon of the transmitter body.

Note

- The Mobrey MSP400RH and MSP900GH are designed to be mounted in a *non-metallic fitting or flange*. The use of metallic fittings/flanges is not recommended.
-

To help installation, flange accessories and bracket kits are available from Emerson Process Management (see Product Data Sheet IP2045 for accessory part numbers). The accessory flanges supplied are manufactured from PVC and are a full face design. Care must be taken when installing to raised face mating flanges on the tank or vessel to prevent distortion of the PVC flange by over-tightening the bolts.

Bracket mounting

The bracket kit contains a stainless steel angle bracket and PVC threaded disc, which may be used to mount the transmitter on a support over the liquid surface. See Product Data Sheet IP2045 for accessory part numbers.

The bracket and disc dimensions are in [Figure A-4 on page 69](#). The combined weight of bracket and disc is 16 oz (0,5 kg). For transmitter weight, see “[Specifications](#)” on [page 63](#).

Bracket installation procedure

1. Attach bracket to the disc using the three screws provided.
2. Attach the assembled bracket and disc to a rigid support over the liquid surface. The bracket may be bolted to a suitable crossmember (structural section of steel).
3. Use PTFE tape on the screw thread ([Figure 3-3 on page 13](#)).
4. Insert the transmitter into the disc.
5. Tighten to a torque of 1.5 lbf.ft. (2 Nm) using the hexagon. *Do not use the transmitter housing to tighten.*

Figure 3-2. Mounting the transmitter using a bracket kit

Note: Combined weight of bracket and disc is 16 oz (0,5 kg).

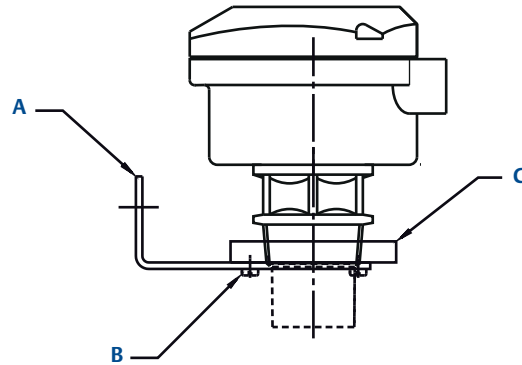

A. Stainless steel bracket

B. No. 4X 13 long self tap screw (3 positions), carbon steel (zinc plated)

C. PVC disc

Installing in a tank with a nozzle or stand-off

Installation procedure

1. Use PTFE tape on the screw thread of the transmitter (Figure 3-3).
2. If the tank has a flanged nozzle or stand-off:
 - a. Attach the transmitter to a non-metal instrument flange using the threaded connection. Tighten to a torque of 1.5 lb-ft (2 N-m) using the transmitter's hexagon.
 - b. The instrument (accessory) flanges supplied by Emerson Process Management are manufactured from PVC and are a full face design. Care must be taken when installing to a raised face mating flange on the tank or vessel to prevent distortion of the PVC flange by over-tightening the bolts.
 - c. Ensure the gasket is sitting correctly on the tank flange.
 - d. Lower the assembled transmitter and instrument flange onto the tank flange, and secure with appropriate bolting to a suitable torque for the flanges.

If mating to a raised face flange (RF) on the tank nozzle or stand-off, tighten to a maximum torque of 10 lb-ft (13.6 N-m).
3. If the tank has a threaded nozzle or stand-off:
 - a. Attach the transmitter to the nozzle/stand-off using the threaded connection.
 - b. Tighten to a torque of 1.5 lb-ft (2 N-m) using the transmitter's hexagon.

Note

- If the transmitter face does not protrude into the vessel, note the dimensions in Table 3-1 on page 3-13 for Figure 3-3, and ensure that the nozzle/vessel weld is smooth and free from internal weld beads or other projections.

Figure 3-3. Mounting the transmitter using a nozzle/stand-off

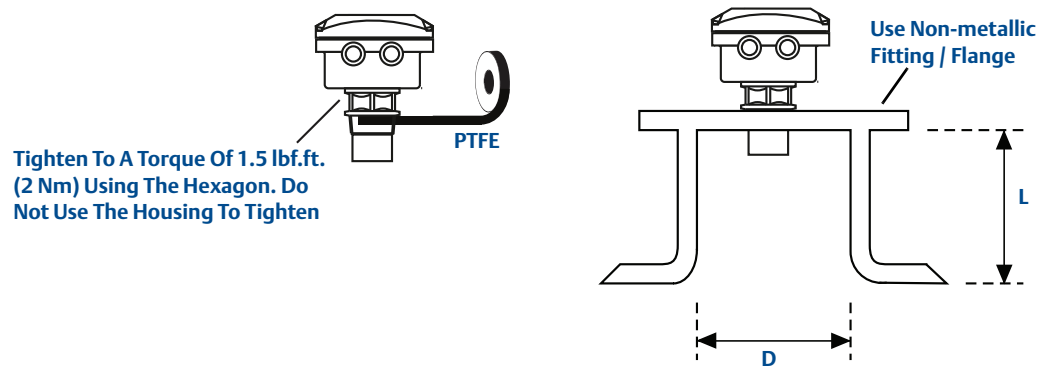

D. See dimension D in Table 3-1.

L. See dimension L in Table 3-1.

Table 3-1. Nozzle diameter size and maximum length

Nozzle Diameter Size (D)	Maximum Nozzle Length (L)
DN50 (2 in.)	4 in. (100 mm)
DN80 (3 in.)	6.3 in. (160 mm)
DN100 (4 in.)	6.3 in. (160 mm)
≥DN125 (5 in.)	11.8 in. (300 mm)

3.3.4 Open channel flow installations

There are normally two distinct parts to an open channel flow measurement system; the primary element (flow structure) and the secondary element (Head measurement instrumentation). For accurate open channel flow measurement, both parts of the system must be correctly installed.

This section explains the important parts of installing the transmitter (secondary element). The flow structure (primary element) installation can be referenced in the British (BS3680) or ISO International standards.

Positioning of the transmitter is critical, and should be the correct distance upstream from the flow structure as stated in the relevant standard for your country. For example, in the ISO standards, the distance should be four to five times the maximum height of the water (H_{max}) for a thin plate weir, or three to four times H_{max} for a flume. For optimum accuracy, the transmitter's front face should be positioned at a height equal to the maximum flow depth plus 14 in. (0,35 m).

Figure 3-4. Choosing the height position above a flow

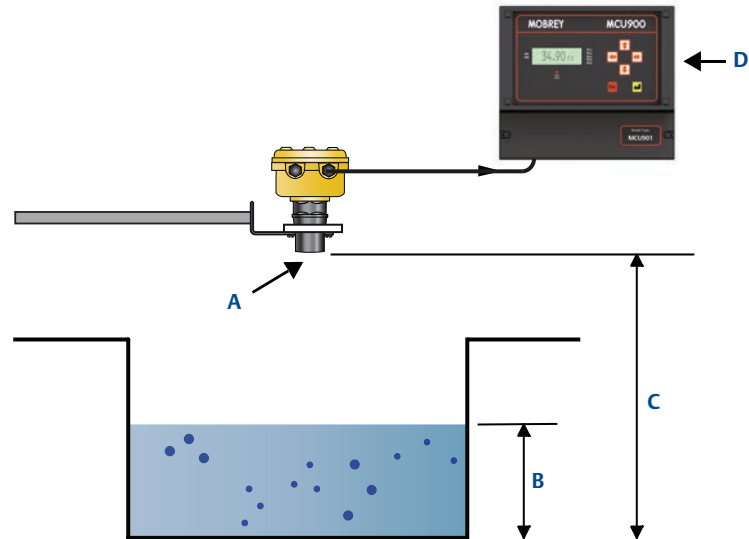

- A. Transmitter front face
- B. Hmax
- C. Hmax + 14 in.
- D. Mobrey MCU900 Series control unit

It is important that the bottom reference of the transmitter should be related to the datum of the primary measuring device (see Figure 3-6).

Figure 3-5. Transmitter bottom reference for a flume or weir

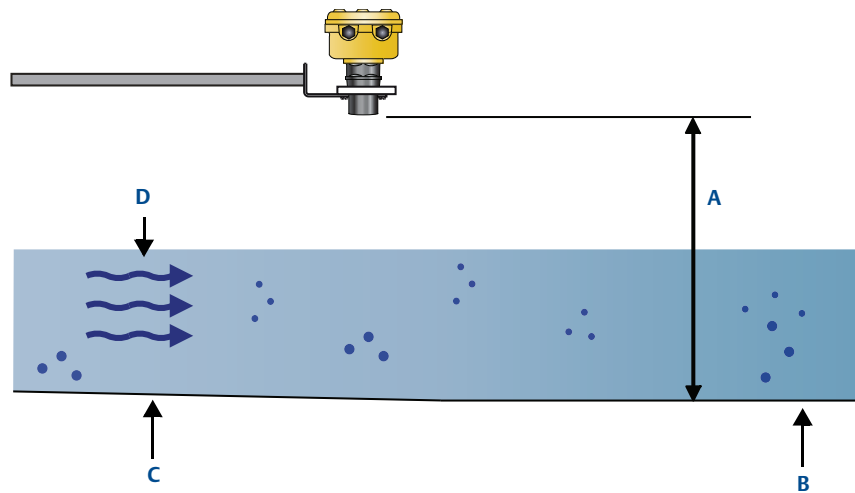

- A. Transmitter bottom reference
- B. Primary element (e.g. flume, weir) invert
- C. Approach channel
- D. Flow direction

Figure 3-6. Transmitter bottom reference for a 'V' notch weir

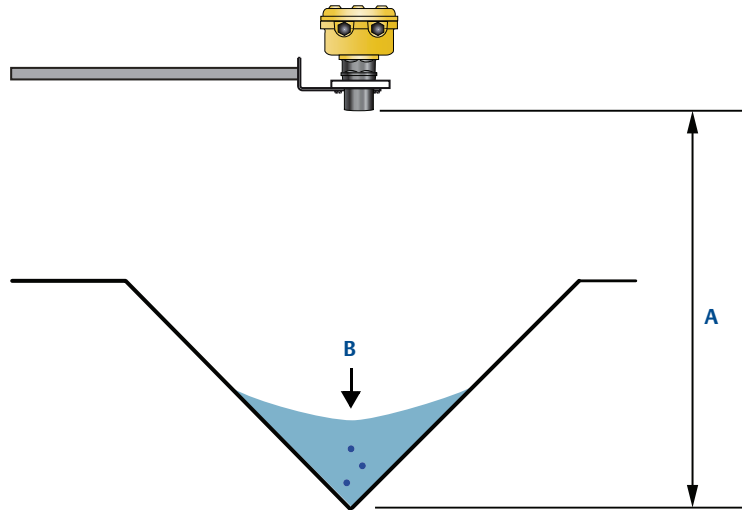

- A. Transmitter bottom reference (i.e. true invert)
- B. Meniscus Level

Note

- The transmitter should be free from a situation where it is likely to 'drown' (refer to relevant Standard for further information).
- The MSP400RH and MSP900GH have the option of a Remote Temperature Sensor for temperature compensation (see “Remote temperature sensor” on page 19). The temperature sensor should be mounted in a location where it can get an accurate air temperature measurement and is protected from sunlight.
- If the flow structure permits, mount the transmitter within the flow channel or chamber. Shroud the transmitter from direct sunlight for maximum accuracy and stability.

3.4 Electrical installation

3.4.1 Connecting the cable(s) to the transmitter

The Mobrey MSP400RH and MSP900GH are two-wire loop-powered transmitters accepting power supplies as follows:

- MSP400RH: 12 to 40 Vdc (non-hazardous area only)
- MSP900GH: 12 to 40 Vdc (non-hazardous area) or 12 to 30 Vdc (hazardous area)

Note

- To comply with the CSA approval, a transmitter must be powered from a Mobrey MCU900 Series control unit, or a class 2 or separate extra-low voltage (SELV) source.
 - Other devices may reset if connecting the transmitter to a multi-drop system while the loop is powered. De-energize the loop to avoid devices being reset
-

Each transmitter is supplied with two cable entries. A suitable conduit system or cable gland must be used to maintain the weather-proof rating and hazardous area protection. Any unused entry must be sealed with a suitably rated blanking plug.

A two-core, shielded/screened cable is required for external power supply and output signal connections. The cable is not supplied.

Connect the cable(s) to the transmitter

1. Make sure that the power supply is disconnected.
2. Undo the three cover screws and then lift the transmitter housing cover.
3. Pass the cable through the cable gland/conduit.
4. Connect the cable wires:
 - a. For the MSP400RH, see [“Connecting the cable wires to the MSP400RH”](#) on page 17.
 - b. For the MSP900GH, see [“Connecting the cable wires to the MSP900GH”](#) on page 18.
5. Connect the cable shield/screen to a suitable ground (earth) at one end only.
6. Replace the cover, tighten the cable gland, and connect the power supply.

What to do after completing the cabling

To maintain the weather-proof rating and hazardous area protection of the transmitter, ensure all cable glands, blanking plugs, and seals are in good condition.

Check that the cover seal is in good condition, and not twisted or misaligned in the seal location groove. When replacing the cover, tighten the three cover screws evenly to exert uniform pressure on the cover seal.

3.4.2 Connecting the cable wires to the MSP400RH

Connect the cable wires to the transmitter as shown in Figure 3-7. See also “Wiring to allow HART communications” on page 19 if HART digital communications is required.

Note

- Make sure the power supply is off when connecting the transmitter.
- The MSP400RH is not intrinsically safe, and is for use in non-hazardous (ordinary location) installations only.

Table 3-2. Terminal connections on the MSP400RH

Connections	
Terminal 1	24 Vdc
Terminal 2	0 Vdc
Terminal 3	RL1 (SPST) - see “Relays” on page 18
Terminal 4	RL1 (SPST) - see “Relays” on page 18
Terminal 5	RL2 (SPST) - see “Relays” on page 18
Terminal 6	RL2 (SPST) - see “Relays” on page 18
Terminal 7	Remote temperature sensor (if used) - see page 19
Terminal 8	Remote temperature sensor (if used) - see page 19
Earth Screen	Connect the cable shield/screen to ground (earth) in the control room

Figure 3-7. Wiring Diagram for The MSP400RH

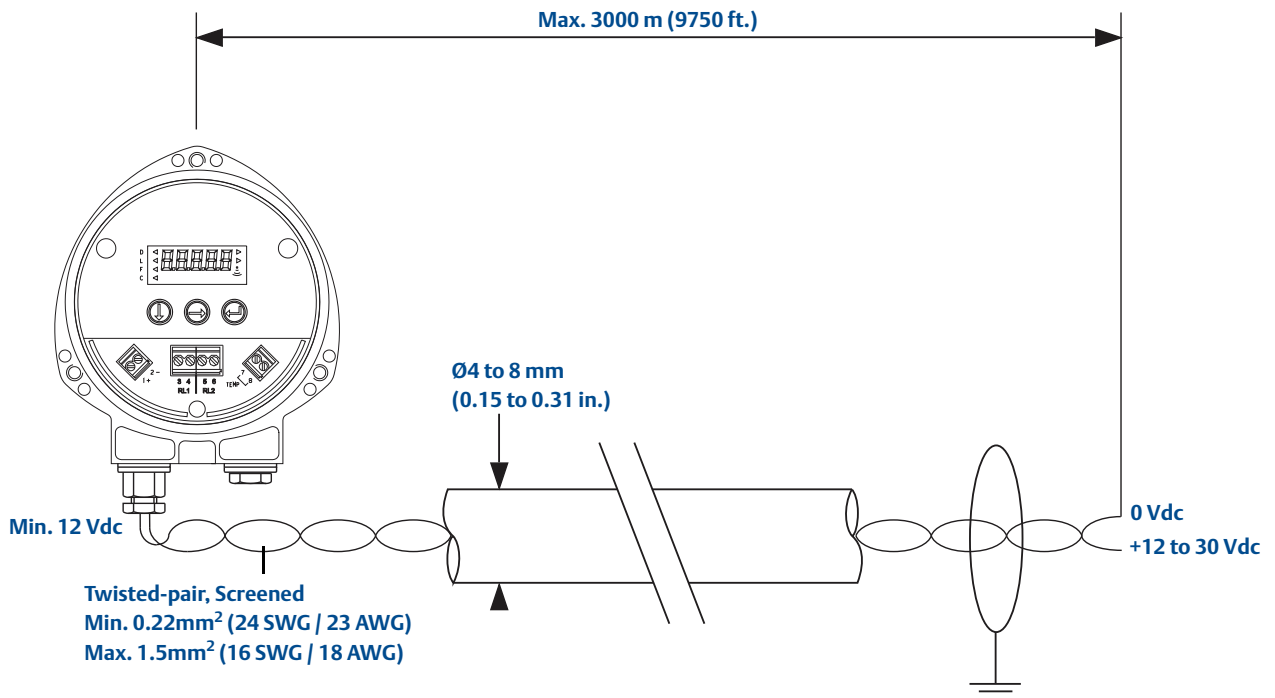

Relays

The MSP400RH has two integral relays which may be used for fault indication or control purposes. These relays are for *light duty* and should be used as signal relays only, with control functions being performed by external control relays.

- Relay 2 is defaulted as a 'fault' relay - normally energized - but may be re-configured on-site as a set-point relay if required.
- Relay status indicators are on the LCD inside the housing (see “Display and push-buttons” on page 21.)

3.4.3 Connecting the cable wires to the MSP900GH

The MSP900GH is for intrinsically safe installations.

Note

- Make sure the power supply is off when connecting the transmitter.
-

Installation in a non-hazardous (ordinary location) area

Connect the cable wires to the transmitter as shown in [Figure 3-8 on page 19](#). See also “Wiring to allow HART communications” on page 19 if HART digital communications is required.

Installation in a hazardous area

Connect the cable wires to the transmitter as shown in [Figure 3-8 on page 19](#). See also “Wiring to allow HART communications” on page 19 if HART digital communications is required.

When the MSP900GH is powered by a Mobrey MCU900 Series control unit, *no safety barriers are required* as the output from the control unit is Intrinsically Safe.

If powering the transmitter from any other power supply, ensure a suitable intrinsically safe barrier is fitted in the non-hazardous (safe) area. The barrier must be chosen such that its output parameters U_o , I_o and P_o are less than U_i , I_i and P_i of the transmitter (see [Appendix B: Product Certifications](#)). The sum of the capacitance and the inductance of the transmitter and the connecting cable fitted must not exceed the maximum specified for the barrier chosen.

Note

- Make sure that the instruments in the loop are installed according to intrinsically-safe field wiring practices and control drawings, when applicable.
-

Table 3-3. Connections for The MSP900GH

Connections	
Terminal 1	24 Vdc
Terminal 2	0 Vdc
Terminal 7 ⁽¹⁾	Remote temperature sensor (if used).
Terminal 8 ⁽¹⁾	Remote temperature sensor (if used).
Earth Screen	Connect the cable shield/screen to ground (earth) in the control room.

(1) See “Remote temperature sensor” on page 19 for further information.

Figure 3-8. Wiring diagram for the MSP900GH

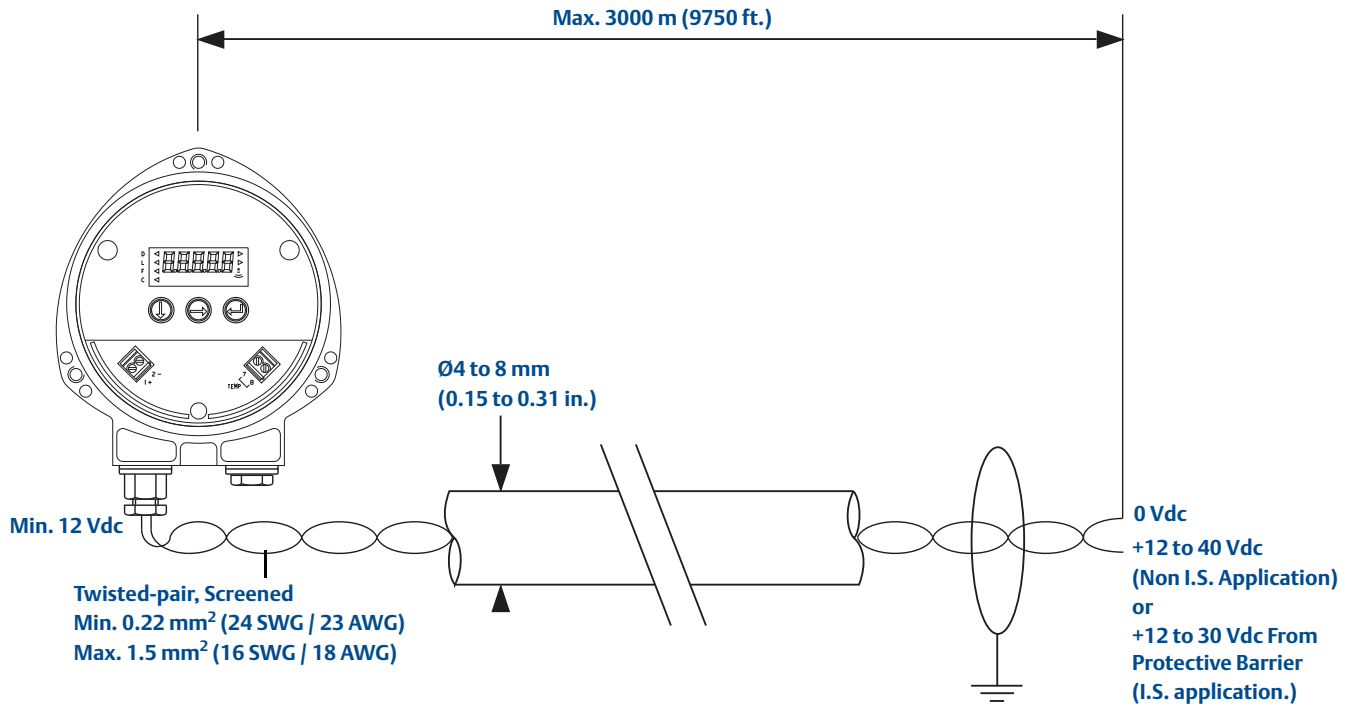

3.4.4 Remote temperature sensor

The MSP400RH and MSP900GH accept input from a Mobrey Remote Temperature Sensor (see Product Data Sheet IP2045 for accessory part numbers).

This is a thermistor-based temperature sensor designed for use with the MSP400RH and MSP900GH.

Full installation instructions are supplied with the temperature sensor, but it should be mounted out of direct sunlight in a position so that it can give a representative reading of the air temperature between the liquid surface and the transmitter.

Note

- Do not connect any other temperature sensor to the MSP400RH or the MSP900GH.

3.4.5 Wiring to allow HART communications

If HART communications is required, a 250 Ohms (minimum), 0.25 W load resistor must be installed in the loop. (See "Dimension drawings" on page 68).

Note

- When the transmitter is used with a Mobrey MCU900 Series control unit, there is no need to install an external load resistor in the loop because a suitable resistor is built in to the control unit.

If the transmitter is being supplied through a safety barrier, ensure the type chosen will pass HART information.

After the load resistor is installed, a Field Communicator can be connected across the load resistor. It is the responsibility of the installer to ensure that any Field Communicator used in the hazardous area is suitably certified.

Note

- Make sure that the instruments in the loop are installed according to intrinsically-safe field wiring practices and control drawings, when applicable.
-

3.4.6 Lightning / Surge protection and other loop devices

If the area is prone to lightning strikes or voltage surges, a suppressor device may be installed between the transmitter and the control unit.

If an additional loop-powered device or separately powered device is included in the two-wire loop, ensure the transmitter receives a minimum voltage of 12 Vdc. (See “[Dimension drawings](#)” on page 68).

Section 4 Starting up

Overview	page 21
Programming	page 23
Final checks	page 43
Power failure	page 43

4.1 Overview

Mobrey MSP400RH and MSP900GH ultrasonic liquid level transmitters are operated from a menu of parameters, each held in a specific memory location within the transmitter. The memory locations may be pictured as a matrix, and navigated for programming the instrument using ↓ and → steps.

The Integral Display Menu structure is shown in [Appendix C: Integrated Display Menus](#).

The transmitter is pre-programmed at the factory with a value in each parameter location so that when the power is first applied, the transmitter gives a sensible reading. Default values are listed in [Appendix D: Mobrey MCU900 Series](#).

The MSP400RH and MSP900GH are HART-enabled, allowing remote communications with the instrument. The transmitter can be programmed using a suitable HART-compatible master, or locally using the push-buttons provided inside the transmitter.

Note

- This section details the local programming. Refer to [Appendix F: Configuring Using HART](#) if using a Mobrey MCU900 Series control unit or a Field Communicator.
-

4.1.1 Display and push-buttons

The integral display allows up to five characters. In **running mode**, the **Primary Value (PV)** measurement is displayed. In **programming mode**, data is displayed to assist with programming.

To the left of the main display are **four arrow icons**; one will be illuminated to indicate the selected duty.

To the right of the PV display on The MSP400RH are **two arrow icons** that indicate the status of the transmitter relays. When illuminated, they indicate the relay contact is closed.

Under the PV display is a **text string** indicating the units of measurement. The transmitter will illuminate only those characters applicable to the units of measurement chosen.

To the right of the text string is an **echo received icon**. It is made up of three arc segments that continuously indicate the strength of the echo received (minimum, average, and good).

Figure 4-1. Display and push-buttons

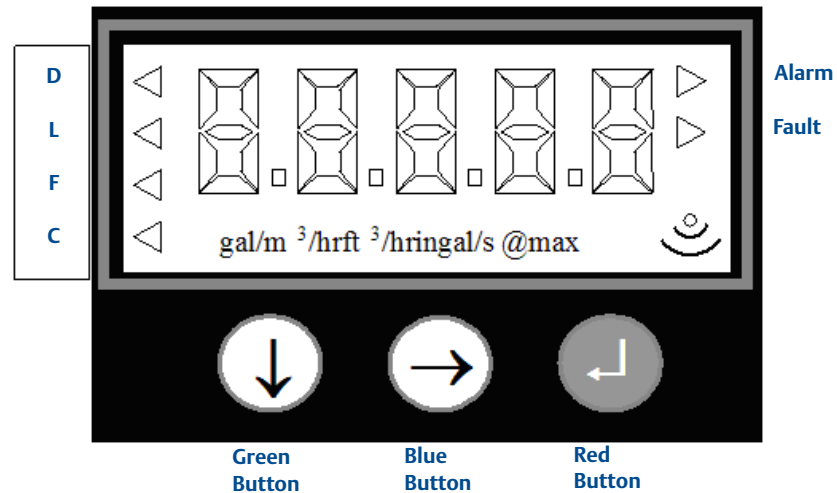

4.1.2 Power up

When the power is turned on, the transmitter takes several seconds to initialize. The display will run a set-up routine, first illuminating all display characters, and then showing the software revision number. Finally, a full set of zeros is displayed while the microprocessor identifies the correct return echo. After these checks are complete, the display indicates the live measurement based upon the factory default values in memory.

On a new instrument aimed at a good target, the transmitter calculates a level reading based upon the default value for the bottom reference.

The duty icon against the letter **L** on the top plate, and the **RL2** icon on The MSP400RH, will be illuminated. The **RL1** icon on the MSP400RH may be illuminated, depending on the level calculated by the transmitter at this time.

The transmitter is now ready to be set-up with details of the application.

The transmitter may be programmed prior to, or after, installation. All programmed data is retained in the transmitter memory after the power is turned off.

4.1.3 Before programming

Important notes to help you program the transmitter

- Do not allow rain, or water, to enter the transmitter during programming or the circuit boards may be damaged.
- See the instructions below on how to use the push-buttons to navigate through the programming menu and select or enter application data.
- Push the buttons firmly, but not too hard, to avoid damaging the circuit boards. Also, to avoid entering incorrect data, do not push the buttons too fast.
- Holding down the green button ↓ scrolls through any option list.
- Pressing the red button ↵ at any time will return you to the previous level in the menu.
- If the red button ↵ is pressed after new data has been entered, the new data will automatically be saved.
- The transmitter has a “re-set default values” routine that reloads the transmitter memory with the factory default values. This will clear the memory of any previous data entered on site.

4.2 Programming

Menu structures for this section are in [Appendix C: Integrated Display Menus \(page 75\)](#).

If using a HART Master Device for programming the MSP400RH or the MSP900GH, refer to the following sections for menu structures and parameters:

- [Appendix D: Mobrey MCU900 Series \(page 81\)](#)
- [Appendix E: Field Communicator \(page 85\)](#)
- [Appendix F: Configuring Using HART \(page 89\)](#)

4.2.1 Overview

Transmitter programming is most easily accomplished by *first* selecting the **duty** that the transmitter is to perform. After a duty is selected (see below), a “mini-wizard” programming assistant is invoked that asks only for information relevant to the selected duty. Entered data allows the mini-wizard to populate relevant parameters with application specific data and select the next step required to configure the transmitter.

Note

- It is advised to enter the “**duty**” menu when programming the transmitter, initiating the mini-wizard to assist with programming.
-

After programming is complete, the data entered or calculated by the transmitter can be reviewed by going through the menu using the green button ↓. This is a manual navigation of the menus, and all menus are shown regardless of the duty selected; the mini-wizard is only initiated when a duty is selected. Ignore menus that do not relate to your application.

4.2.2 Selecting the duty

Screen display: **dutY**
Factory default setting: **Level**

The arrow icon on the left side of the PV display indicates the selected duty. The MSP400RH and MSP900GH may be programmed to perform one of four duties:

1. Distance measurement.
2. Level measurement (factory default setting).
3. Flow measurement.
4. Contents (Volume) measurement.

Note

- This menu option is in the programming menu. See [Figure C-1 on page 76](#) for a map of the menu structure and how to access the menu options.
-

To change the duty

1. Press the green button ↓ to enter the menu system from the PV display (see the note above.) The display indicates “**dutY**”.
2. Press the blue button → to enter the “**dutY**” menu and display the presently selected duty: “**LEVEL**”, “**Flo**”, “**cont**”, or “**dist**”.
3. If the duty is correct, press the red button ↵ and then the green button ↓ to get to the next menu option.
4. Press the blue button → to start the editing mode. The duty flashes to indicate it may now be edited.
5. Press the green button ↓ repeatedly to scroll through the list of duties.
6. Press the blue button → to confirm the duty. The flashing then stops.
7. If the new duty is correct, press the red button ↵ to save. The display will change to the next menu option.
8. If the new duty is incorrect, press the blue button → to exit to the menu. The menu option “**dutY**” re-appears; re-start at step (b) or press ↓ to get to the next menu option.

4.2.3 Selecting the units of measurement

Screen display: **units**
Factory default setting: **m** (metric) or **ft** (Imperial)

The transmitter is pre-programmed with selectable measurement units for each of the duties:

1. Distance and Level measurement: **m**, **ft**, or **in**
2. Flow measurement: **l/s**, **l/m**, **m³/hr**, **gal/m**, **m ga**, **ft³/m (cfm)**, or **ft³/hr**
3. Contents measurement: **l**, **m³**, **gal**, or **ft³**

Note

- The factory default units of measurement are dictated by the model part number (see ordering information tables in Product Data Sheet IP2045).
A Metric unit can be re-configured to be an Imperial unit, or vice-versa, by changing the base units (**b.unit**) of the transmitter. See “[Changing the base units](#)” on page 60.
 - **Changing base units after programming the transmitter will cause all programmable data to be overwritten with factory default values.**
 - The **units** menu option is in the programming menu. See [Figure C-1 on page 76](#) for a map of the menu structure and how to access all the menu options.
-

To change the measurement units

1. If entering the menu system from the PV display, press the green button ↓ repeatedly until the “**units**” menu option is indicated (see note above.)
2. Press the blue button → to enter the “**units**” menu. (The presently selected units are indicated on the bottom display line.)
3. If the units are correct, press the red button ↵ and then the green button ↓ to exit to the next menu option.
4. Press the blue button → to start the editing mode. The present units flash to indicate it may be edited.
5. Press the green button ↓ repeatedly to scroll through the list of units.
6. Press the blue button → to confirm the new units. The flashing stops.
7. If the new units are correct, press the red button ↵ to save and get to the next menu.
8. If the new units are incorrect, press the blue button → to exit to the menu. The menu option “**units**” re-appears; re-start at step (2) or press ↓ to get to the next menu.

Note

- When using the green button ↓ to scroll through the measurement units, allow three seconds after each button press for the transmitter to check and display the selection.
 - After changing units, a scaling factor (see “[K-factor for the flow law](#)” on page 32) needs to be edited to see the correct PV.
-

4.2.4 Setting the correct bottom reference

Screen display: **b.rEF**
Factory default value: **11**

The transmitter leaves the factory with the bottom reference pre-programmed to the maximum range of the instrument 36 ft. (11 m).

Note

- It is important to not enter a value greater than the maximum range of the transmitter, which is 36 ft. (11 m).

Figure 4-2. Transmitter bottom reference

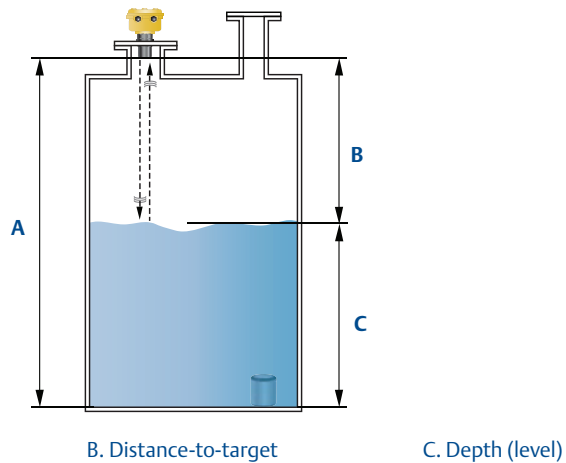

Note

- This menu option is in the programming menu. See [Figure C-1 on page 76](#) for a map of the menu structure and how to access the menu options.

To change the bottom reference

- If entering the menu system from the PV display, press the green button ↓ repeatedly until the “b.rEF” menu option is indicated (see note above.)
- Press the blue button → to enter the “b.rEF” menu and display the present bottom reference (b.rEF) value.
- If this value is correct, press the red button ↵ and then the green button to get to the next menu option.
- Press the blue button → to start the editing mode. The first digit flashes to indicate it can now be edited.
- Press the green button ↓ repeatedly to edit the flashing digit.
- Press the blue button → to select the next digit. The digit flashes to indicate it can be edited.

7. Repeat steps (5) and (6) until the last digit is flashing, and edited as required.
8. Press the blue button → to confirm the new **b.rEF** value. None of the digits should now be flashing.
9. If the new **b.rEF** value is correct, press the red button ↵ to save. The display will change to the next menu option.
10. If the new value is incorrect, press the blue button → to exit to the menu. The “**b.rEF**” re-appears; re-start at step (2) or press ↓ for the next menu.

Note

- If the saved duty is **Flow** or **Contents**, the next menu option is “**ProF**” (see “[Selecting a profile](#)” on page 27).
 - If the saved duty is **Level** or **Distance**, the next menu option is “**4**” (see “[Setting the 4 mA point](#)” on page 36).
 - A useful feature at this stage is that the transmitter can be used as an electronic tape measure. With an empty tank or vessel, the transmitter will read the distance to the bottom of the tank. This distance can be noted and later used when setting **b.rEF**.
-

4.2.5 Selecting a profile

Screen display: **ProF**
Factory default value: **Lin**

This menu is offered if the selected duty is **Contents (Volume)** or **Flow**, or is shown when manually navigating the menu system - *this section can be ignored if the selected duty is Level or Distance*.

The transmitter is pre-programmed with popular profiles that are mathematical formulas to convert (scale) a **linear level** reading to a **flow** or **volumetric PV**. Once converted (scaled), the 4–20 mA Output and the Integral Display will operate according to the flow or volumetric PV.

The profile options are described in the following sections:

- “[Contents \(volume\) measurement](#)” on page 27
- “[Flow measurement](#)” on page 28

Contents (volume) measurement

Lin	Linear (factory default setting)
H.CYL.F	Horizontal cylinder on it' side with flat ends
SPH.	Spherical vessel
H.CYL.D	Horizontal cylinder on its side with dished ends

Note

- This menu option is in the programming menu. See [Figure C-1 on page 76](#) for a map of the menu structure and how to access the menu options.
-

To change the contents profile

1. If entering the menu system from the PV display, press the green button ↓ repeatedly until the “**ProF**” menu option is indicated (see note on previous page).
2. Press the blue button → to enter the “**ProF**” menu and display the present profile selection.
3. If the selected profile is correct, press the red button ↵ to exit to the menu. (The menu option “**ProF**” re-appears. To get to the next menu, press ↓.)
4. Press the blue button → to start the editing mode. The selected profile flashes to indicate it can now be edited.
5. Press the green button ↓ repeatedly to scroll through the list of profiles (see above.)
6. Press the blue button → to confirm the new profile. (The flashing stops.)
7. If the new profile is correct, press the red button ↵ to save. The display will change to the next menu option.
8. If the new profile is incorrect, press the blue button → to exit to the menu. The “**ProF**” re-appears; re-start at step (2) or press ↓ for the next menu.

Note

- If the saved profile is “**Lin**”, the next menu option is “**SCALE**” (see “[K-factor for the flow law](#)” on page 32).
 - If another contents profile is saved, the next menu is “**Cont @ max**” (see “[Maximum contents \(volume\) entry](#)” on page 35).
-

Flow measurement

Table 4-1 lists the options that select a standard flow structure for the profile and the conversion (scale) factors used to obtain the flow PV.

There are two other profiles:

- **SPEC.P** (Special Plotted)
This option is only visible when the transmitter is configured using a HART Master (e.g. a Mobrey MCU900 Series control unit).
- **SPEC.C** (Special Calculated)
This option is used when a standard profile is not available from the transmitter’s library. A power factor and a K-factor can be edited for an unsupported flow structure, or to allow for imperfections in a standard flow structure. (See “[Power Factor for the Flow Law](#)” on page 31 and “[K-factor for the flow law](#)” on page 32).

Note

- This menu option is in the programming menu. See [Figure C-1 on page 76](#) for a map of the menu structure and how to access the menu options.
-

To change the flow profile

1. If entering the menu system from the PV display, press the green button ↓ repeatedly until the “**ProF**” menu option is indicated (see note on previous page).
2. Press the blue button → to enter the “**ProF**” menu and display the present profile selection.
3. If the selected profile is correct, press the red button ↵ to exit to the menu. (The menu option “**ProF**” re-appears. To get to the next menu, press ↓.)
4. Press the blue button → to start the editing mode. The selected profile flashes to indicate it can now be edited.
5. Press the green button ↓ repeatedly to scroll through the list of profiles (see [Table 4-1 on page 4-30](#).)
6. Press the blue button → to confirm the new profile. (The flashing stops.)
7. If the new profile is correct, press the red button ↵ to save. The display changes to the next menu option.
8. If the new profile is incorrect, press the blue button → to exit to the menu. The “**ProF**” re-appears; re-start at step (2) or press ↓ for the next menu.

Note

The next menu option will depend upon the flow profile chosen:

- 3/2 or 5/2: the transmitter will automatically calculate the Power factor and only requires the K factor to be entered. (see “[K-factor for the flow law](#)” on page 32).
 - Manning: the next menu option is “**LEUEL @ max**” (see “[Maximum level entry](#)” on page 33).
 - Parshall, FF, or FP: the transmitter will automatically calculate the appropriate Power factor and K factor, and will set the 4 mA point at zero flow and the 20 mA point at maximum flow. (See “[Setting the output damping](#)” on page 38).
-

Table 4-1. Profile options for flow

Options	Flow Structures	Hmax		Scale Factor		Power Factor	20 mA Point ⁽¹⁾	
		Metric (m)	Imperial (ft/in.)	Metric (m ³ /hr) ⁽²⁾	Imperial (GPM) ⁽²⁾		Metric (m)	Imperial (ft/in.)
3/2	Flume 3/2 flow law	-		(User) ⁽³⁾	(User) ⁽³⁾	1.5	(User) ⁽³⁾	(User) ⁽³⁾
5/2	V-Notch 5/2 flow law	-		(User) ⁽³⁾	(User) ⁽³⁾	2.5	(User) ⁽³⁾	(User) ⁽³⁾
mann	Manning formula	-		(User) ⁽³⁾	(User) ⁽³⁾	(User) ⁽³⁾	-	-
PAr01	1 inch Parshall flume	0.75	2.5	217.3	151.7	1.55	17.9	87.3
PAr02	2 inch Parshall flume	0.75	2.5	434.6	303.4	1.55	50.7	215
PAr03	3 inch Parshall flume	0.75	2.5	635.5	445.2	1.547	125	516
PAr06	6 inch Parshall flume	0.75	2.5	1372	924.5	1.58	389	1750
PAr09	9 inch Parshall flume	0.75	2.5	1927	1378	1.53	882	3980
PAr1	1 ft. Parshall flume	0.75	2.5	2487	1795	1.522	1610	7240
PAr1.5	1 1/2 ft. Parshall flume	0.75	2.5	3803	2693	1.538	2440	11000
PAr2	2 ft. Parshall flume	0.75	2.5	5143	3590	1.550	3290	14900
PAr3	3 ft. Parshall flume	0.75	2.5	7863	5386	1.566	5010	22600
PAr4	4 ft. Parshall flume	0.75	2.5	10630	7181	1.578	6750	30500
PAr5	5 ft. Parshall flume	0.75	2.5	13440	8976	1.587	8510	38400
PAr6	6 ft. Parshall flume	0.75	2.5	16280	10770	1.595	10300	46400
PAr8	8 ft. Parshall flume	0.75	2.5	22010	14360	1.607	13900	62600
PAr10	10 ft. Parshall flume	0.75	2.5	26862	17672	1.6	20700	89200
FF01 ⁽⁴⁾	Flume Flat 1 (m)	0.102		134.79		1.5	9	
FF02 ⁽⁴⁾	Flume Flat 2 (m)	0.191		178.27		1.5	36	
FF03 ⁽⁴⁾	Flume Flat 3 (m)	0.267		313.42		1.5	90	
FF04 ⁽⁴⁾	Flume Flat 4 (m)	0.406		541.72		1.5	360	
FF05 ⁽⁴⁾	Flume Flat 5 (m)	0.635		811.11		1.5	900	
FF06 ⁽⁴⁾	Flume Flat I	0.200		132.2		1.5	30	
FF07 ⁽⁴⁾	Flume Flat II	0.250		177.7		1.5	60	
FF08 ⁽⁴⁾	Flume Flat III	0.300		217.58		1.5	90	
FF09 ⁽⁴⁾	Flume Flat III bis	0.3333		328.35		1.5	200	
FF10 ⁽⁴⁾	Flume Flat III ter	0.400		272.0		1.5	200	
FF11 ⁽⁴⁾	Flume Flat IV	0.400		352.17		1.5	180	
FF12 ⁽⁴⁾	Flume Flat V	0.500		442.93		1.5	360	
FF13 ⁽⁴⁾	Flume Flat V bis	0.400		400.5		1.5	320	
FF14 ⁽⁴⁾	Flume Flat VI	0.540		499.06		1.5	720	
FF15 ⁽⁴⁾	Flume Flat VII	0.700		623.7		1.5	1080	
FF16 ⁽⁴⁾	Flume Flat VIII	0.600		881.16		1.5	1440	
FF17 ⁽⁴⁾	Flume Flat VIII bis	0.666		798.0		1.5	1500	
FF18 ⁽⁴⁾	Flume Flat IX	0.800		1065.2		1.5	1800	
FF19 ⁽⁴⁾	Flume Flat IX bis	0.733		814.8		1.5	1700	
FF20 ⁽⁴⁾	Flume Flat X	0.867		1322.3		1.5	3600	
FF21 ⁽⁴⁾	Flume Flat X bis	1.200		1609.0		1.5	7500	
FF22 ⁽⁴⁾	Flume Flat X ter	0.959		1064.9		1.5	3500	
FF23 ⁽⁴⁾	Flume Flat XI	1.200		1651.0		1.5	7200	
FP01 ⁽⁴⁾	Flume Parabolic 1	0.200		15879		2.3	20	
FP02 ⁽⁴⁾	Flume Parabolic 2	0.250		17591		2.3	40	
FP03 ⁽⁴⁾	Flume Parabolic 3	0.310		11646		2.2	90	
FP04 ⁽⁴⁾	Flume Parabolic 4	0.380		13670		2.2	180	
FP05 ⁽⁴⁾	Flume Parabolic 5	0.460		9802.7		2.1	360	
FP06 ⁽⁴⁾	Flume Parabolic 6	0.600		11368		2.1	720	
FP07 ⁽⁴⁾	Flume Parabolic 7	0.800		12228		2.1	1400	

(1) Where entries do not say "(User)", the 20 mA Point (Upper Range Value) is automatically set to the value in the meters (m) or feet/inches (ft./in.) column depending on the selected Base Units. The 4 mA Point (Lower Range Value) is automatically set to 0.

(2) If the Base Units are meters (m), the flow units are m³/hour. Otherwise, flow units are gal/m (GPM). The gallons are US gallons.

(3) Where shown, "(User)" indicates that the user is required to input the appropriate data.

(4) FF and FP flume options require the Base Units to be meters (m). See "Changing the base units" on page 60 if a change of Base Units is required.

4.2.6 Power Factor for the Flow Law

Screen display: **P . FAcT**
Factory default value: **1 . 000**

This menu is offered if the selected duty is Flow and a profile (e.g. “SPEC.C”) requires the manual editing of a power factor in the formula:

Flow $Q = kh^*$ (where * = the power factor)

The transmitter is pre-programmed with appropriate power factors for many standard flow profiles, and will automatically select the appropriate factor (See [Table 4-1 on page 4-30](#)). Alternatively, the power factor may be edited to suit a specific flow structure.

Note

- This menu option is in the programming menu. See [Figure C-1 on page 76](#) for a map of the menu structure and how to access the menu options.
-

To change the power factor

1. If entering the menu system from the PV display, press the green button ↓ repeatedly until the “P . FAcT” menu option is indicated (see note above.)
2. Press the blue button → to enter the “P . FAcT” menu and display the present power factor.
3. If the power factor is correct, press the red button ↵ to exit to the menu. (The menu option “P . FAcT” re-appears. To get to the next menu, press ↓).
4. Press the blue button → to start the editing mode. The first digit flashes to indicate it can now be edited.
5. Press the green button ↓ repeatedly to edit the flashing digit.
6. Press the blue button → to move to the next digit. The digit flashes to indicate it can be edited.
7. Repeat steps (5) and (6) until the last digit is flashing, and edited as required.
8. Press the blue button → to confirm the new value. (The flashing stops).
9. If the new value is correct, press the red button ↵ to save. The display changes to the next menu option.
10. If the new value is incorrect, press the blue button → to exit to the menu.
11. The “P . FAcT” menu re-appears to re-start at step (2) or press ↓ for next menu.

4.2.7 K-factor for the flow law

Screen display:	SCALE
Factory default value:	1.000

Note

- If a flow duty has been selected, the value entered into this parameter is in effect the K-factor in a flow law of the form $Flow\ Q = kh^*$.

If a Distance, Level or Contents (Volume) duty has been selected, the value entered into this parameter is a factor used to scale the measured distance, level, or volume.

For a Level or Distance duty, the scaling factor is normally left at the value calculated by the transmitter (depending upon previously entered data and duty selected), or the default value of 1.000.

For a linear Contents duty, enter a scaling factor to convert the level measurement to a volume measurement. If the measurement units are “m”, enter the volume contained in 1 m of liquid height in the tank. If the units of measurements are “ft”, then enter the volume contained in 1 ft. of liquid height in the tank.

Note

- This menu option is in the programming menu. See [Figure C-1 on page 76](#) for a map of the menu structure and how to access the menu options.

To change the scale factor

1. If entering the menu system from the PV display, press the green button ↓ repeatedly until the “**SCALE**” menu option is indicated (see above note).
2. Press the blue button → to enter the “**SCALE**” menu and to display the present scale factor.
3. If the scale factor is correct, press the red button ↵ to exit to the menu. (The menu option “**SCALE**” re-appears. To get to the next menu, press ↓).
4. Press the blue button → to start the editing mode. The first digit flashes to indicate it can now be edited.
5. Press the green button ↓ repeatedly to edit the flashing digit.
6. Press the blue button → to move to the next digit. The digit flashes to indicate it can be edited.
7. Repeat steps (5) and (6) until the last digit is flashing, and edited as required.
8. Press the blue button → to confirm the new value. (The flashing stops).
9. If the new value is correct, press the red button ↵ to save. The display changes to the next menu option.
10. If the new value is incorrect, press the blue button → to exit to the menu.
11. The “**SCALE**” menu re-appears to re-start at step (2) or press ↓ for the next menu.

Note

- If the existing data entered allows the transmitter to calculate the maximum flow, the 4 mA and 20 mA points are set to 4 mA at zero flow and 20 mA at maximum flow.
-

4.2.8 Maximum level entry

Screen display: **LEUEL @ max**
Factory default value: **1.000**

This menu option is offered if the selected duty is Flow and requires the level to be entered at which the maximum flow occurs.

Note

- This menu option is in the programming menu. See [Figure C-1 on page 76](#) for a map of the menu structure and how to access the menu options.
-

To change the Level@max value

1. If entering the menu system from the PV display, press the green button ↓ repeatedly until the “**LEUEL @ max**” menu is indicated (see above note).
2. Press the blue button → to enter the “**LEUEL @ max**” menu and display the present Level@max value.
3. If the indicated value is correct, press the red button ↵ to exit to the menu. (The “**LEUEL @ max**” re-appears. To get to the next menu, press ↓).
4. Press the blue button → to start the editing mode. The first digit flashes to indicate it can now be edited.
5. Press the green button ↓ repeatedly to edit the flashing digit.
6. Press the blue button → to move to the next digit. The digit flashes to indicate it can be edited.
7. Repeat steps (5) and (6) until the last digit is flashing, and edited as required.
8. Press the blue button → to confirm the new value. (The flashing stops.)
9. If the new value is correct, press the red button ↵ to save. The display changes to the next menu option.
10. If the new value is incorrect, press the blue button → to exit to the menu.
11. The menu option “**LEUEL @ max**” re-appears to re-start at step (2) or press ↓ for the next menu option.

4.2.9 Maximum flow entry

Screen display: **Flo @ max**
Factory default value: **1.000**

This menu option is offered if the selected duty is Flow and requires entry of the maximum flow capability of the chosen structure (not the maximum flow expected in the application).

Note

- This menu option is in the programming menu. See [Figure C-1 on page 76](#) for a map of the menu structure and how to access the menu options.
-

To change the Flo@max value

1. If entering the menu system from the PV display, press the green button ↓ repeatedly until the “**Flo @ max**” menu is indicated (see above note).
2. Press the blue button → to enter the “**Flo @ max**” menu and display the present Flo@max value.
3. If the Flo@max value is correct, press the red button ↵ to exit to the menu. (The menu “**Flo @ max**” re-appears. To get to the next menu, press ↓).
4. Press the blue button → to start the editing mode. The first digit flashes to indicate it can now be edited.
5. Press the green button ↓ repeatedly to edit the flashing digit.
6. Press the blue button → to move to the next digit. The digit flashes to indicate it can be edited.
7. Repeat steps (5) and (6) until the last digit is flashing, and edited as required.
8. Press the blue button → to confirm the new value. (The flashing stops.)
9. If the new value is correct, press the red button ↵ to save. The display changes to the next menu option.
10. If the new value is incorrect, press the blue button → to exit to the menu.
11. The menu “**Flo @ max**” re-appears to re-start at step (2) or press ↓ for the next menu.

Note

- If the data entered allows the transmitter to calculate the maximum flow, the 4 and 20 mA points are set to 4 mA at zero flow and 20 mA at maximum flow.
-

4.2.10 Maximum contents (volume) entry

Screen display: **Cont @ max**

Factory default value: **1.000**

This menu option is offered if the selected duty is Contents (Volume) and requires entry of the maximum contents of the vessel.

Note

- This menu option is in the programming menu. See [Figure C-1 on page 76](#) for a map of the menu structure and how to access the menu options.
-

To change the Cont@max value

1. If entering the menu system from the PV display, press the green button ↓ repeatedly until the “**Cont @ max**” menu is indicated (see above note.)
2. Press the blue button → to enter the “**Cont @ max**” menu and display the present Cont@max value.
3. If the Cont@max value is correct, press the red button ↵ to exit to the menu. (The menu option “**Cont @ max**” re-appears. To get to the next menu, press ↓.)
4. Press the blue button → to start the editing mode. The first digit flashes to indicate it can now be edited.
5. Press the green button ↓ repeatedly to edit the flashing digit.
6. Press the blue button → to move to the next digit. The digit flashes to indicate it can be edited.
7. Repeat steps (5) and (6) until the last digit is flashing, and edited as required.
8. Press the blue button → to confirm the new value. (The flashing stops.)
9. If the new value is correct, press the red button ↵ to save. The display changes to the next menu option.
10. If the new value is incorrect, press the blue button → to exit to the menu.
11. The menu “**Cont @ max**” re-appears to re-start at step (2) or press ↓ for the next menu.

4.2.11 Setting the 4 mA point

Screen Display: **4**
Factory default value: **0.000**

Enter the PV value to be signalled by 4 mA. The 4 mA point can be set above or below the 20 mA point to suit monitoring or control equipment.

The 4 and 20 mA points can be set by ranging the transmitter to a fixed target, such as the level in the vessel. If this is required, press the green button ↓ twice to get to the damping (**d**) menu option and see “[Setting the output damping](#)” on page 38.

Note

- This menu option is in the programming menu. See [Figure C-1 on page 76](#) for a map of the menu structure and how to access the menu options.
-

To change the 4 mA point

1. If entering the menu system from the PV display, press the green button ↓ repeatedly until the “**4**” menu option is indicated (see above note).
2. Press the blue button → to enter the “**4**” menu and to display the present 4 mA point value.
3. If the 4 mA point value is correct, press the red button ↵ to exit to the menu. (The menu option “**4**” re-appears. To go to the next menu, press ↓).
4. Press the blue button → to start the editing mode. The first digit flashes to indicate it can now be edited.
5. Press the green button ↓ repeatedly to edit the flashing digit.
6. Press the blue button → to move to the next digit. The digit flashes to indicate it can be edited.
7. Repeat steps (5) and (6) until the last digit is flashing, and edited as required.
8. Press the blue button → to confirm the new value. (The flashing stops).
9. If the new value is correct, press the red button ↵ to save. The display changes to the next menu option.
10. If the new value is incorrect, press the blue button → to exit to the menu.
11. The menu “**4**” re-appears to re-start at step (2) or press ↓ for the next menu.

4.2.12 Setting the 20 mA point

Screen Display:	20
Factory default value:	10.7

Enter the PV value to be signalled by 20 mA. The 20 mA point may be set above or below the 4 mA point to suit monitoring or control equipment.

Note

- This menu option is in the programming menu. See [Figure C-1 on page 76](#) for a map of the menu structure and how to access the menu options.
-

To change the 20 mA point

1. If entering the menu system from the PV display, press the green button ↓ repeatedly until the “20” menu option is indicated (see above note.)
2. Press the blue button → to enter the “20” menu and to display the present 20 mA point value
3. If the 20 mA point is correct, press the red button ↵ to exit to the menu. (The menu option “20” re-appears. To get to the next menu, press ↓).
4. Press the blue button → to start the editing mode. The first digit flashes to indicate it can now be edited.
5. Press the green button ↓ repeatedly to edit the flashing digit.
6. Press the blue button → to move to the next digit. The digit flashes to indicate it can be edited.
7. Repeat steps (5) and (6) until the last digit is flashing, and edited as required.
8. Press the blue button → to confirm the new value. (The flashing stops).
9. If the new value is correct, press the red button ↵ to save. The display changes to the next menu option.
10. If the new value is incorrect, press the blue button → to exit to the menu.
11. The menu “20” re-appears to re-start at step (2) or press ↓ for the next menu.

4.2.13 Setting the output damping

Screen display:	d
Factory default value:	3

The damping value is a time constant in seconds, and is applied as smoothing to the displayed PV and the output current.

A new value may be entered up to 999 seconds. A large value will have the effect of smoothing out rapid changes to the PV value, and smooth out the effects of turbulence and ripples on the liquid surface. (It would be unusual to select a value greater than 30 seconds.)

A value of zero may be edited, in which case no smoothing is applied to the Current Output and transmitter readings immediately change the output.

Note

- A damping time of zero will not necessarily give an immediate response because the MSP400RH and MSP900GH transmits nominally at once per second.
 - This menu option is in the programming menu. See [Figure C-1 on page 76](#) for a map of the menu structure, showing how to access the menus.
-

To change the damping value

1. If entering the menu system from the PV display, press the green button ↓ repeatedly until the “**d**” menu option is indicated (see above note.)
2. Press the blue button → to enter the “**d**” menu and to display the present damping value.
3. If the damping value is correct, press the red button ↵ to exit to the menu. (The menu option “**d**” re-appears. To get to the next menu, press ↓.)
4. Press the blue button → to start the editing mode. The first digit flashes to indicate it can now be edited.
5. Press the green button ↓ repeatedly to edit the flashing digit.
6. Press the blue button → to move to the next digit. The digit flashes to indicate it can be edited.
7. Repeat steps (5) and (6) until the last digit is flashing, and edited as required.
8. Press the blue button → to confirm the new value. (The flashing stops.)
9. If the new value is correct, press the red button ↵ to save. The display changes to the next menu option.
10. If the new value is incorrect, press the blue button → to exit to the menu.
11. The menu “**d**” re-appears to re-start at step (2) or press ↓ for the next menu.

4.2.14 Selecting the alarm condition action

Screen display: **AL**
Factory default value: **Hold**

The MSP400RH and MSP900GH can signal an alarm condition if the target echo is lost for 900 seconds or more. The 900 seconds is factory set and is changeable in the field.

There are three actions to choose from:

- Hi** The current on the two-wire loop increases to 21 mA. The current stays at that level until the correct target echo is recovered. The display flashes alternately “**LE**” and the last PV.
- Hold** The current freezes at the last PV value and stays frozen until the correct target echo is recovered. The display flashes alternately “**LE**” and the last PV.
- Lo** The current on the two-wire loop decreases to 3.6 mA. The current stays at that level until the correct target echo is recovered. The display flashes alternately “**LE**” and the last PV.

Note

- This menu option is in the programming menu. See [Figure C-1 on page 76](#) for a map of the menu structure and how to access the menu options.
-

To change the selected action

1. If entering the menu system from the PV display, press the green button ↓ repeatedly until the “**AL**” menu option is indicated (see above note.)
2. Press the blue button → to enter the “**AL**” alarm menu and display the selected action.
3. If the selected action is correct, press the red button ↵ to exit to the menu. (The menu option “**AL**” re-appears. To get to the next menu, press ↓.)
4. Press the blue button → to start the editing mode. The selected action flashes to indicate it can now be edited.
5. Press the green button ↓ repeatedly to scroll through the list of actions (see above).
6. Press the blue button → to confirm the new action. (The flashing stops).
7. If the new action is correct, press the red button ↵ to save. The display changes to the next menu option.
8. If the new action is incorrect, press the blue button → to exit to the menu.
9. The menu “**AL**” re-appears to re-start at step (2) or press ↓ for the next menu.

4.2.15 Setting the relay on and off points (MSP400RH)

The MSP400RH has two integral signal relays. Both relays are the SPST (Single Pole, Single Throw) type.

RL1 is factory-set to be a *control relay*. It may be set to energise at any value of PV, and de-energise at any other value of PV. Setting the on and off points to a common PV will turn the relay off. The on value may be greater or smaller than the off value, and vice-versa.

RL2 is factory-set to be a *fault relay*. In this mode, it de-energizes under Lost Echo (LE) or fault conditions. The relay de-energizes if the power fails.

The mode of RL2 may be changed to control mode by entering on and off values (use RL1 instructions below). In control mode, RL2 ceases to be a fault relay until the On and Off values are reset to zero.

All relay set-point values must be entered in the units selected for the PV.

Note:

This menu option is in the programming menu. See [Figure C-1 on page 76](#) for a map of the menu structure and how to access the menu options.

To change the On PV point for control relay RL1 (or RL2)

1. If entering the menu system from the PV display, press the green button ↓ repeatedly until the “**r1 on**” (or “**r2 on**”) menu option is indicated (see above note).
2. Press the blue button → to enter the “**r1 on**” (or “**r2 on**”) menu and display the present On PV value.
3. If the On PV value is correct, press the red button ↵ to exit to the menu. (The “**r1 on**” or “**r2 on**” re-appears. To get to the next menu, press ↓).
4. Press the blue button → to start the editing. The first digit flashes to indicate it can be edited.
5. Press the green button ↓ repeatedly to edit the flashing digit.
6. Press the blue button → to move to the next digit. The digit flashes to indicate it can be edited.
7. Repeat steps (5) and (6) until the last digit is flashing, and edited as required.
8. Press the blue button → to confirm the new value. (The flashing stops).
9. If the new value is correct, press the red button ↵ to save. The display changes to the next menu option.
10. If the new value is incorrect, press the blue button → to exit to the menu.
11. The menu “**r1 on**” (or “**r2 on**”) re-appears to re-start at step (2) or press ↓ for the next menu.

Note

- This menu option is in the programming menu. See [Figure C-1 on page 76](#) for a map of the menu structure and how to access the menu options.
-

To change the Off PV point for control relay RL1 (or RL2)

1. If entering the menu system from the PV display, press the green button ↓ repeatedly until the “**r1 off**” (or “**r2 off**”) menu option is indicated (see above note).
2. Press the blue button → to enter the “**r1 off**” (or “**r2 off**”) menu and display the present Off PV value.
3. If the Off PV value is correct, press the red button ↵ to exit to the menu. (The menu “**r1 OFF**” (or “**r2 OFF**”) re-appears. To get to the next menu, press ↓).
4. Press the blue button → to start the editing. The first digit flashes to indicate it can be edited.
5. Press the green button ↓ repeatedly to edit the flashing digit.
6. Press the blue button → to move to the next digit. The digit flashes to indicate it can be edited.
7. Repeat steps (5) and (6) until the last digit is flashing, and edited as required.
8. Press the blue button → to confirm the new value. (The flashing stops).
9. If the new value is correct, press the red button ↵ to save. The display changes to the next menu option.
10. If the new value is incorrect, press the blue button → to exit to the menu.
11. The menu “**r1 OFF**” (or “**r2 OFF**”) re-appears to re-start at step (2) or press ↓ for the next menu.

4.2.16 Setting the 4 and 20 mA levels using ranging

Screen display: (SEt 4 and SEt 20)

If you have already programmed the 4 and 20 mA levels as above, you do not need to enter this menu; **it overwrites previously entered data for them.**

All the programming is now complete and you should press the red button ↵ to exit the programming menu and return to the main PV display.

If, however, you wish to set the 4 or 20 mA level by ranging the instrument to a known target - perhaps the level in the vessel at this time - then press the blue button → to enter this menu.

Note

- This “**SEt 4**” menu option is in the programming menu. See [Figure C-1 on page 76](#) for a map of the menu structure and how to access the menu options.
-

To set the 4 mA level

1. If entering the menu system from the PV display, press the green button ↓ repeatedly until the “**SEt 4**” menu option is indicated (see note on the previous page).
2. Press the blue button → to display the PV at 4 mA.
3. If the value is correct, press the red button ↵ to exit to the menu.
(The “**SEt 4**” re-appears. To get to the “**SEt 20**” menu, press ↓).
4. With the transmitter aimed at a target a distance away equivalent to the 4 mA level, press the blue button → to start the ranging. The display alternately flashes “4” and the live measurement reading.
5. Press the blue button → to confirm the PV at 4 mA is to be changed to the same value as the live measurement reading.
6. If the new PV at 4 mA value is correct, press the red button ↵ to save and then the green button ↓ to get to the “**SEt 20**” menu.
7. If the new PV at 4 mA value is incorrect, press the blue button → to exit to the menu.
8. The menu “**SEt 4**” re-appears to re-start at step (2) or press ↓ to get to the “**SEt 20**” menu.

Note

- This “**SEt 20**” menu option is in the programming menu. See [Figure C-1 on page 76](#) for a map of the menu structure and how to access the menu options.
-

To set the 20 mA level

1. If entering the menu system from the PV display, press the green button ↓ repeatedly until the “**SEt 20**” menu option is indicated (see note above).
2. Press the blue button → to display the PV at 20 mA.
3. If the value is correct, press the red button ↵ to exit to the menu.
(The “**SEt 4**” re-appears. To get to the next menu, press ↓.)
4. With the transmitter aimed at a target a distance away equivalent to the 20 mA level, press the blue button → to start the ranging. The display alternately flashes “20” and the live measurement reading.
5. Press the blue button → to confirm the PV at 20 mA is to be changed to the same value as the live measurement reading.
6. If the new PV at 20 mA value is correct, press the red button ↵ to save and then the green button ↓ to exit the menu system and return to the PV display.
7. If the new PV at 20 mA value is incorrect, press the blue button → to exit to the menu.
8. The menu “**SEt 20**” re-appears to re-start at step (2) or press ↓ to exit the menu system and change to the PV display.

Programming of the transmitter is now complete.

Check the main display to ensure the duty, units and PV are correct, and that relays are on or off according to the set points programmed. The cover may now be replaced (see “[What to do after completing the cabling](#)” on page 16).

4.3 Final checks

Final checks

1. Check the display is reading correctly.
2. You may wish to check echo size again before re-fitting the enclosure lid.
3. Check that the cover seal is in place in the cover, and is good condition. It should not be twisted or kinked in any way.
4. Carefully set the cover on the transmitter, and tighten the three cover screws equally to seal the instrument.
5. Check that the cable gland is securely tightened and check sealing on the cable sheath.

4.4 Power failure

All parameters are held in EPROM memory. In the event of a power failure, or disconnection from the power supply, the transmitter will remember all of its last parameter values and will resume correct operation once power is restored.

Section 5 Service and Troubleshooting

Safety messages	page 45
Servicing	page 46
Diagnostics	page 46
Engineering menu	page 49
False echoes under certain ambient operating conditions	page 62

5.1 Safety messages

Procedures and instructions in this manual may require special precautions to ensure the safety of the personnel performing the operations. Information that raises potential safety issues is indicated by a caution symbol (⚠). The external hot surface symbol (🔥) is used when a surface is hot and care must be taken to avoid possible burns. If there is a risk of an electrical shock the (⚡) symbol is used. Refer to the safety messages listed at the beginning of each section before performing an operation preceded by this symbol.

⚠ WARNING

Failure to follow these installation guidelines could result in death or serious injury

- Make sure only qualified personnel perform the installation.
- Use the equipment only as specified in this manual. Failure to do so may impair the protection provided by the equipment.

Explosions could result in death or serious injury

- Verify that the operating environment of the transmitter is consistent with the appropriate hazardous locations certifications.
- Before connecting a HART[®]-based communicator in an explosive atmosphere, make sure the instruments in the loop are installed in accordance with intrinsically safe or non-incendive field wiring practices.

Electrical shock could cause death or serious injury

- Use extreme caution when making contact with the leads and terminals.

⚠ WARNING

Any substitution of non-recognized parts may jeopardize safety. Repair, e.g. substitution of components etc., may also jeopardize safety and is under no circumstances allowed.

5.2 Servicing

The only maintenance required is to occasionally check the transmitter face to ensure it remains clean and check that the cover seal, wiring, and cable glands are in good condition.

There are no spare parts for the Mobrey MSP400RH and MSP900GH. If a problem persists, contact Rosemount Measurement for advice.

5.3 Diagnostics

Menu structures for this section are in [Appendix C: Integrated Display Menus \(page 75\)](#)

Note

If using a HART Master Device for programming the MSP400RH or MSP900GH, refer to the following sections for menu structures and parameters:

- [Appendix D: Mobrey MCU900 Series \(page 81\)](#)
 - [Appendix E: Field Communicator \(page 85\)](#).
 - [Appendix F: Configuring Using HART \(page 89\)](#)
-

5.3.1 General troubleshooting

No display

Check the power supply. Ensure there is a minimum of 12 Vdc at the instrument terminals. Check that the cable insulation is not preventing contact at the terminal block.

No level reading

Check that the instrument is ticking about once per second. If there is no ticking, the instrument should be replaced.

5.3.2 Diagnostic data

The MSP400RH and MSP900GH can display diagnostic data that can aid setting-up and fault-finding. To aid interpretation, the data will alternate with text to remind what data is being displayed. In the diagnostic menu, the data cannot be edited.

To enter the diagnostic menu from the PV display, press the blue button → to display the menu option “**diAg**”.

Note

- See [Figure C-2 on page 78](#) for a map of the diagnostics menu structure.
-

Diagnostic information is then available by following this sequence

1. Press the green button ↓ to display the distance-to-target in the selected base units (m, ft., or in.). The transmitter is measuring distance-to-target regardless of the duty selected.

(Press the red button \blacktriangleleft at any time to re-display the “**diAg**” menu option, and pressing it again restores the PV display.)

2. Press the green button \downarrow to get to the next diagnostic data, “**LEVEL**”.
This is the level measurement in base units that the transmitter has calculated based upon the bottom reference and the distance measured, regardless of the duty chosen for the instrument.
3. Press the green button \downarrow to get to the next diagnostic data, “**Echo. s**”.
This is the echo size being received on a scale of 0 to 100. It is recommended that a value greater than 10 be achieved.
4. Press the green button \downarrow to get to the next diagnostic data, “**Echo. n**”.
This is the number of echoes being received and can be an indicator of the data being processed by the transmitter. A thorough understanding of ultrasonic level systems is required to interpret this data.
5. Press the green button \downarrow to get to the next diagnostic data, “**F**”.
This is the frequency at which the transmitter is operating, and should read between 49 and 58 kHz.
6. Press the green button \downarrow to get to the next diagnostic data, “**t**”.
This is the temperature being recorded by the integral temperature sensor (or remote temperature sensor, if fitted) and is being used by the transmitter to calculate the distance-to-target.
7. Press the green button \downarrow and then the blue button \rightarrow to change to the PV display.

5.3.3 Loop test

Screen display: **tEst**

The transmitter can cycle through the programmed operating range without any change in the liquid level, causing the current output to cycle through a normal operation (and energize/de-energize relays on the MSP400RH).

The transmitter can be programmed to fix the loop current at any value between 4 and 20 mA to allow testing of any other loop or control instruments.

To enter the loop test menu from the PV display, press the blue button \rightarrow to display “**diAg**” and then press-and-hold the blue button \rightarrow for at two seconds to display “**tEst**”.

Note

- See [Figure C-2 on page 78](#) for a map of the diagnostics menu structure.
-

Cycle function

Screen display: **CyCLE**

1. After entering the “**tEst**” menu (see above), press the green button \downarrow to get to the “**CyCLE**” menu option.

2. Press the blue button → to enter the “**CyCLE**” menu. The display indicates “0.0000”.
3. Press the blue button → to start the cycle.
For 100 seconds, the transmitter cycles from the 4 mA value to the maximum PV value and back to the 4 mA value again.
Press the green button ↓ at any time to pause and resume the cycle.
4. Press the blue button → to exit the cycle and re-display “**CyCLE**”.

Loop-current fixing

Screen display: **LOOP**

1. From the “**tEST**” or “**CyCLE**” display, press the green button ↓ to get to the “**LOOP**” menu.
2. Press the blue button → to enter the “**LOOP**” menu, and the display will zero to show “0.000”.
3. Press the blue button → to start the editing mode. The first digit flashes to indicate it can now be edited.
4. Press the green button ↓ repeatedly to edit the flashing digit.
5. Press the blue button → to move to the next digit. The digit flashes to indicate it can be edited.
6. Repeat steps (4) and (5) until the last digit is flashing, and edited as required.
7. Press the blue button → to confirm the fixed loop current.
8. To change the fixed current value to a new value, press the blue button → to return to the “**LOOP**” menu and re-start at step (2).
9. Press the green button ↓ to return to displaying the “**tEST**” menu option.
10. From “**tEST**”, press the red button ↵ to change to the PV display.
Alternatively, from “**tEST**”, press and hold both the blue → and the red ↵ buttons together for 2 seconds to get to the Engineering “**Eng**” menu (see “Engineering menu” on page 49).

5.4 Engineering menu

Menu structures for this section are in [Appendix C: Integrated Display Menus \(page 75\)](#)

Note

If using a HART Master Device for programming the MSP400RH or MSP900GH, refer to the following sections for menu structures and parameters:

- [Appendix D: Mobrey MCU900 Series \(page 81\)](#)
 - [Appendix E: Field Communicator \(page 85\)](#).
 - [Appendix F: Configuring Using HART \(page 89\)](#)
-

5.4.1 Accessing the engineering menu

Screen display: **Eng**

The transmitter can be fine-tuned if site or application conditions are unusual. It is recommended that all operational fine tuning parameters remain at the factory default settings unless there is a good understanding of the function and capability of the parameters.

The “reload factory defaults” function is found in this menu, and should be used if the transmitter has been configured incorrectly, or if the transmitter needs to be reset to factory default values.

To reach the Engineering menu option “Eng”

1. Begin from the PV display. ([Figure C-1 on page 76](#) is a map of the menu structure).
2. Press the blue button → to indicate the “**DiAg**” menu option. (To exit to the PV display, press the red button ↵).
3. Hold down the blue button → for 2 seconds, and then release. The display changes to the “**tEst**” menu option. (To exit to the PV display, press ↵).
4. Hold down both the blue button → and red button ↵ for 2 seconds. The display changes to the “**Eng**” menu option. (To exit to the PV display, press ↵).
5. Press the green button ↓ to enter the “**Eng**” menu. The display indicates the first engineering menu option “**t.HoLd**” (see below).

5.4.2 Setting the threshold

Screen display: **t.HoLd**

Factory default value: **Auto**

False echoes are rejected below the threshold value. “Auto” sets the threshold level for optimum performance based on echo sizes being received. A value up to 99 may be entered. However, a large value will have the effect of stopping false echo processing.

Note

- This menu option is in the engineering menu “**Eng**”. See “[Accessing the engineering menu](#)” on page 49 or see [Figure C-3 on page 79](#) for a map of the menu structure.
-

To change the threshold value

1. After entering the “**Eng**” menu (see the note above), the first menu option indicated is “**t.HoLd**”.
2. Press the blue button → to enter the menu for “**t.HoLd**”.
The display indicates the present threshold value.
3. If the threshold value is correct, press the red button ↵ to exit to the menu.
(The menu option “**t.HoLd**” re-appears. To get to the next menu option, press the green button ↓).
4. Press the blue button → to start the editing mode. If the present setting is “Auto”, press the green button ↓ to change to a three digit number. The first of the three digits flashes to indicate a number can now be edited.
5. Press the green button ↓ repeatedly to edit the flashing digit. (To restore the “**Auto**” setting, scroll past “**9**” and press the red button ↵ to save and exit).
6. Press the blue button → to move to the next digit. The digit flashes to indicate it can be edited.
7. Repeat steps (5) and (6) until the last digit is flashing, and edited as required.
8. Press the blue button → to confirm the new value. (The flashing stops.)
9. If the new value is correct, press the red button ↵ to save. The display changes to the next menu option.
10. If the new value is incorrect, press the blue button → to exit to the menu.
11. The menu “**t.HoLd**” re-appears to re-start at step (2) or press ↓ for the next menu.

5.4.3 Setting lost echo time

Screen display: **LE**
Factory default value: **900**

The lost echo time is the seconds that the transmitter will wait before taking the lost echo alarm action (see “[Selecting the alarm condition action](#)” on page 39).

A value up to 9999 can be entered. It is recommended that the lost echo time remains set to 900 seconds to avoid false trips and alarms from a temporary loss of echo caused by transient poor surface conditions.

A lower lost echo time should only be programmed if it is important that the lost echo alarm action is taken more quickly (see “[Selecting the alarm condition action](#)” on page 39).

Note

- This menu option is in the engineering menu “**Eng**”. See “[Accessing the engineering menu](#)” on page 49 or see [Figure C-3](#) on page 79 for a map of the menu structure.
-

To change the lost echo time

1. After entering the “**Eng**” menu (see the note above), press the green button ↓ repeatedly until “**LE**” is indicated.
2. Press the blue button → to enter the menu for “**LE**”. The display indicates the present lost echo time value.
3. If this lost echo time is correct, press the red button ↵ to exit to the menu. (The menu option “**LE**” re-appears. To get to the next menu, press ↓.)
4. Press the blue button → to start the editing mode. The first digit flashes to indicate it can now be edited.
5. Press the green button ↓ repeatedly to edit the flashing digit.
6. Press the blue button → to move to the next digit. The digit flashes to indicate it can be edited.
7. Repeat steps (5) and (6) until the last digit is flashing, and edited as required.
8. Press the blue button → to confirm the new value. (The flashing stops).
9. If the new value is correct, press the red button ↵ to save. The display changes to the next menu option.
10. If the new value is incorrect, press the blue button → to exit to the menu.
11. The menu “**LE**” re-appears to re-start at step (2) or press ↓ for the next menu.

5.4.4 Setting the dead band

Screen display: **dEAd**
Factory default value: **0.3 (m)**

The dead band is a region below the transmitter face in where no measurements can be made. This is also known as the Blanking or Blocking zone, and is a feature common to all ultrasonic level transmitters, with a value dependent upon certain intrinsic properties of the transmitter.

The dead band should not be lower than the factory default minimum value unless advised by the manufacturer. A higher value may be entered to stop the processing of echoes from false targets, but real echoes in the dead band will also now be ignored.

Note

- This menu option is in the engineering menu “**Eng**”. See “[Accessing the engineering menu](#)” on page 49 or see [Figure C-3](#) on page 79 for a map of the menu structure.
-

To change the dead band

1. After entering the “**Eng**” menu (see the note above), press the green button ↓ repeatedly until “**dEAd**” is indicated.
2. Press the blue button → to enter the dead band menu. The display indicates the present dead band value.
3. If this dead band is correct, press the red button ↵ to exit to the menu. (The menu option “**dEAd**” re-appears. To get to the next menu, press ↓).
4. Press the blue button → to start the editing mode. The first digit flashes to indicate it can now be edited.
5. Press the green button ↓ repeatedly to edit the flashing digit.
6. Press the blue button → to move to the next digit. The digit flashes to indicate it can be edited.
7. Repeat steps (5) and (6) until the last digit is flashing, and edited as required.
8. Press the blue button → to confirm the new value. (The flashing stops).
9. If the new value is correct, press the red button ↵ to save. The display changes to the next menu option.
10. If the new value is incorrect, press the blue button → to exit to the menu.
11. The menu “**dEAd**” re-appears to re-start at step (2) or press ↓ for the next menu.

5.4.5 Setting the frequency

Screen display: **F**
Factory default value: **Auto**

The frequency at which the transmitter operates is automatically chosen by the microprocessor to ensure optimum signal size and performance.

“Auto” sets the frequency to obtain the best echo size and optimum performance. The actual frequency being used by the transmitter can be viewed in diagnostics (see [page 46](#)).

The limits of operating frequency are a function of the intrinsic properties of the transmitter itself, and may be set to operate at any frequency between 49 and 58 kHz.

The transmit frequency affects the quality of the echo being received, which may be used to improve a poor echo or reduce the quality of a false echo.

Note

- This menu option is in the engineering menu “**Eng**”. See “[Accessing the engineering menu](#)” on [page 49](#) or see [Figure C-3](#) on [page 79](#) for a map of the menu structure.
-

To change the frequency

1. After entering the “**Eng**” menu (see the note above), press the green button ↓ repeatedly until “**F**” is indicated.
2. Press the blue button → to enter the frequency menu. The display indicates the present frequency setting.
3. If this frequency is correct, press the red button → to exit to the menu. (The menu option “**F**” re-appears. To get to the next menu, press ↓).
4. Press the blue button → to start the editing mode. The present frequency setting flashes to indicate it can be edited.
5. Press the green button ↓ repeatedly to scroll through available options (49 to 58 kHz). (To restore the “**Auto**” setting, scroll past “**58 kHz**” and press the red button ↵ to save and exit).
6. Press the blue button → to confirm the new setting. (The flashing stops).
7. If the new setting is correct, press the red button ↵ to save. The display changes to the next menu option.
8. If the new setting is incorrect, press the blue button → to exit to the menu.
9. The menu “**F**” re-appears to re-start at step (2) or press ↓ for the next menu.

5.4.6 Setting the pulse repetition frequency

Screen display: **Prf**
Factory default value: **1.0**

The rate of pulses transmitted is set at a factory default value of once-per-second.

The transmitter may be set to transmit faster or slower at selectable repetition rates between 0.5 and 2.0 times per second.

Note

- The is also the ‘cycle time’ of the transmitter.
-

The pulse repetition frequency may be changed to overcome cross talk problems if more than one ultrasonic transmitter is mounted in the same tank.

Note

- This menu option is in the engineering menu “**Eng**”. See “[Accessing the engineering menu](#)” on page 49 or see [Figure C-3](#) on page 79 for a map of the menu structure.
-

To change the pulse repetition frequency

1. After entering the “**Eng**” menu (see the note above), press the green button ↓ repeatedly until “**Prf**” is indicated.
2. Press the blue button → to enter the pulse frequency menu.
The display indicates the present frequency value
3. If this pulse frequency is correct, press the red button ↵ to exit to the menu.
(The menu “**Prf**” re-appears”. To go to the next menu, press ↓).
4. Press the blue button → to start the editing mode. The pulse repetition frequency flashes to indicate it can be edited.
5. Press the green button ↓ repeatedly to scroll through the available options (0.5 to 2.0).
6. Press the blue button → to confirm the new setting. (The flashing stops).
7. If the new setting is correct, press the red button ↵ to save. The display changes to the next menu option.
8. If the new setting is incorrect, press the blue button → to exit to the menu.
9. The menu “**Prf**” re-appears to re-start at step (2) or press ↓ for the next menu.

5.4.7 Setting valid echo count

Screen display: **stir**
Factory default value: **4**

This parameter is normally used in vessels with a stirrer or agitator, particularly if there is slow movement. The transmitter may detect uncovered blades and treat them as a valid echo and calculate an incorrect level reading.

Note

- This menu option is in the engineering menu “**Eng**”. See “[Accessing the engineering menu](#)” on page 49 or see [Figure C-3 on page 79](#) for a map of the menu structure.

To change the valid echo count

1. After entering the “**Eng**” menu (see the note above), press the green button ↓ repeatedly until “**stir**” is indicated.
2. Press the blue button → to enter the stirrer (“**stir**”) menu.
The display indicates the present valid echo count.
3. If the value indicated is correct, press the red button ↵ to exit to the menu.
(The menu option “**stir**” re-appears”. Press ↓ to get to the next menu).
4. Press the blue button → to start the editing mode. The valid echo count flashes to indicate it can be edited.
5. Press the green button ↓ repeatedly to scroll through the options available (1 to 100).
6. Press the blue button → to confirm the new setting. (The flashing stops).

7. If the new setting is correct, press the red button \downarrow to save. The display changes to the next menu option.
8. If the new setting is incorrect, press the blue button \rightarrow to exit to the menu.
9. The menu “**stir**” re-appears to re-start at step (2) or press \downarrow for the next menu.

5.4.8 Setting Spike Rejection

Screen display: **SPi**
Factory default value: 0 (disabled)

In applications with high levels of acoustic or electrical noise, a spike could incorrectly trigger the echo detection system. The value of SPi can be increased (0 to 100) and has the effect of rejecting spikes. Several different values may have to be tried to determine the best option.

Note

- This menu option is in the engineering menu “**Eng**”. See “[Accessing the engineering menu](#)” on page 49 or see [Figure C-3 on page 79](#) for a map of the menu structure.
-

To change the spike rejection

1. After entering the “**Eng**” menu (see the note above), press the green button \downarrow repeatedly until “**SPi**” is indicated.
2. Press the blue button \rightarrow to enter the spike rejection menu. The display indicates the present SPi value.
3. If this SPi is correct, press the red button \downarrow to exit to the main menu. (The menu option “**SPi**” re-appears”. Press \downarrow to get to the next menu).
4. Press the blue button \rightarrow to start the editing mode. The SPi flashes to indicate it can be edited.
5. Press the green button \downarrow repeatedly to scroll through the options available (1 to 100).
6. Press the blue button \rightarrow to confirm the new setting. (The flashing stops).
7. If the new setting is correct, press the red button \downarrow to save. The display changes to the next menu option.
8. If the new setting is incorrect, press the blue button \rightarrow to exit to the menu.
9. The menu “**SPi**” re-appears to re-start at step (2) or press \downarrow for next menu.

5.4.9 Learn about echoes from false targets

Screen display: **Lrn**

The MSP400RH and MSP900GH has an easy-to-use “**Lrn**” (Learn) routine that allows the instrument to learn up to four false echoes, which can then be ignored in future operations.

If the application is simple and there are no false echoes, press the green button ↓ to exit the menu and return to the PV display.

After the transmitter is in operational, if an echo other than the true liquid surface echo is detected and an incorrect level reading is indicated, the instrument can learn to ignore this false echo. The “**Lrn**” routine may be used at any time, either during or after setting-up or if a problem occurs later.

Note

- This menu option is in the engineering menu “**Eng**”. See “[Accessing the engineering menu](#)” on page 49 or see [Figure C-3 on page 79](#) for a map of the menu structure.
-

To store a false target echo

1. After entering the “**Eng**” menu (see the note above), press the green button ↓ repeatedly until “**Lrn**” is indicated.
2. Press the blue button → to enter the “**LrnX**” where “X” (0 to 4) is the number of stored false target echoes.
3. To store a new false echo, press and hold the blue button → for five seconds.
4. The display alternately flashes “**Lrn**” and the false target position. After four seconds, the false target position is stored and the display re-indicates “**LrnX**”.
5. Press the red button ↵ to save this false echo and exit to the menu. If this false echo shouldn't be saved, press the blue button → to exit the menu.
6. To store another false target echo, re-start at step (2).
7. To get to the next menu option, press the green button ↓.

Note

- If there are four false echoes stored (“**Lrn4**”), the transmitter will not allow another echo to be stored until the memory is cleared (see procedure below).
 - When a false echo is stored, the transmitter sets up a 'window' around the false target and ignores any echo from that window, unless the echo received from the liquid surface is larger than the stored false echo. There may be no change in the transmitter output current while the liquid level moves through this window, which is equivalent to a distance of 20 cm.
-

To clear all the stored false echoes

1. After entering the “**Eng**” menu (see the note above), press the green button ↓ repeatedly until “**Lrn**” is indicated.
2. Press the blue button → to enter the “**Lrn**” menu.
3. With the display indicating “**LrnX**”, press and hold the green button ↓ for ten seconds to clear the memory. The display then indicates “**Lrn0**”.
4. To exit to the menu system press the red button ↵.
5. The menu “**Lrn**” re-appears. See the previous procedure for how to store new false echoes or press the green button ↓ to get to the next menu.

5.4.10 Setting the ambient temperature

Screen display: **t**
Factory default value: **Auto**

The transmitter has an integral temperature sensor to measure the temperature of the air space surrounding it so that the speed of sound can be correctly computed for sending pulses. The distance-to-target is then calculated using the formula:

Distance to target = Speed of Sound in air * (Time for echo to return / 2)

Auto indicates the transmitter is set to continuously measure the temperature using the integral temperature sensor. It may, occasionally, be necessary to over-ride this automatic monitoring and fix the temperature to be used in speed-of-sound calculations, for example if the air temperature is not uniform and the temperature being recorded is not the true air temperature.

Note

- This menu option is in the engineering menu “**Eng**”. See “[Accessing the engineering menu](#)” on page 49 or see [Figure C-3 on page 79](#) for a map of the menu structure.
-

To edit and fix the temperature

1. After entering the “**Eng**” menu (see the note above), press the green button ↓ repeatedly until “**т**” is indicated.
2. Press the blue button → to enter the temperature menu. The display indicates the present setting.
3. If this setting is correct, press the red button ↵ to exit to the menu. (The menu “**т**” re-appears”).
4. Press the blue button → to start the editing mode. If the present setting is “Auto”, press the green button ↓ to change to a three digit number. The first of the three digits flashes to indicate a number can now be edited.
5. Press the green button ↓ repeatedly to edit the flashing digit. (To restore the “**Auto**” setting, scroll past “**9**” and press the red button ↵ to save and exit).
6. Press the blue button → to move to the next digit. The digit flashes to indicate it can be edited.
7. Repeat steps (5) and (6) until the last digit is flashing, and edited as required.
8. Press the blue button → to confirm the new value. (The flashing stops).
9. If the new value is correct, press the red button ↵ to save. The display changes to the next menu option.

The next menu is “**т . CAL**” if using the optional Remote Temperature Sensor to measure the air temperature. If the Remote Temperature Sensor option is not fitted, the next menu is “**Ld . def**” (see “[Loading factory default values](#)” on page 59).
10. If the new value is incorrect, press the blue button → to exit to the menu.
11. The menu “**т**” re-appears to re-start at step (2) or press ↓ for the next menu.

5.4.11 Temperature calibration

Screen display: **т . CAL**

This menu option is offered if using the optional Remote Temperature Sensor to monitor air temperature (see “[Remote temperature sensor](#)” on page 19). The recorded temperature can be trimmed to match a another plant reading.

Note

- The Remote Temperature Sensor is of a negative temperature co-efficient (NTC) thermistor design.
 - Due to the effects of cable length and electronic component tolerances, the air temperature measurement by the Remote Temperature Sensor could have an error of ± 0.5 °C.
 - This menu option is in the engineering menu “**Eng**”. See “[Accessing the engineering menu](#)” on page 49 or see [Figure C-3 on page 79](#) for a map of the menu structure.
-

To edit and fix the temperature

1. After entering the “**Eng**” menu (see the note above), press the green button ↓ repeatedly until “**t . CAL**” is indicated.
2. Press the blue button → to enter the “**t . CAL**” menu. The display indicates the present setting.
3. If this setting is correct, press the red button ↵ to exit to the menu. (The menu option “**t . CAL**” re-appears”. Press ↓ to get to the next menu).
4. Press the blue button → to start the editing mode. The first digit flashes to indicate it can now be edited.
5. Press the green button ↓ repeatedly to edit the flashing digit.
6. Press the blue button → to move to the next digit. The digit flashes to indicate it can be edited.
7. Repeat steps (5) and (6) until the last digit is flashing, and edited as required.
8. Press the blue button → to confirm the new value. (The flashing stops).
9. If the new value is correct, press the red button ↵ to save. The display changes to the next menu option.
10. If the new value is incorrect, press the blue button → to exit to the menu. (The menu option “**t . CAL**” re-appears; re-start at step (2) or press ↓ to get to the next menu.)

5.4.12 Loading factory default values

Screen display: **Ld . dEF**

It may, occasionally, be necessary to re-set the transmitter parameters to factory default values, particularly if the data already changed is in question.

To ensure that this operation is not initiated by accident, a specific push-button sequence is necessary to load factory defaults.

Note

- Re-loading factory defaults overwrites all parameters and all site entered data will be lost.
 - This menu option is in the engineering menu “**Eng**”. See “[Accessing the engineering menu](#)” on page 49 or see [Figure C-3 on page 79](#) for a map of the menu structure.
-

To load factory default values

1. After entering the “**Eng**” menu (see the note above), press the green button ↓ repeatedly until “**Ld.dEF**” is indicated.
2. Press the blue button → to enter the load defaults “**Ld.dEF**” menu and display “**LOAD**”.
3. Press and hold the blue button → for two seconds to flash the screen message “**SurE**”.
4. Press the blue button → again to acknowledge the message and stop the message flashing.
5. Press the blue button → to abort and exit to the menu. (The menu option “**Ld.dEF**” re-appears”. Press ↓ to get to the next menu).
6. To load factory defaults, press and hold both the blue → and red ↵ buttons together for two 2 seconds.
The screen flashes “**b.units**” and reloads all factory default values.
The display changes to the PV display.

5.4.13 Changing the base units

Screen display: **b.unit**
Factory default: metric (m) or imperial (ft)

The transmitter may be re-configured to operate in a choice of base units:

- metres
- feet
- inches

Note

- If the base units are changed, the transmitter automatically re-starts as if it were a new instrument on first power-up, but will default to the chosen base units and load factory default values into all other parameters.
 - This menu option is in the engineering menu “**Eng**”. See “[Accessing the engineering menu](#)” on page 49 or see [Figure C-3 on page 79](#) for a map of the menu structure.
-

To change the base units

1. After entering the “**Eng**” menu (see the note above), press the green button ↓ repeatedly until “**b.unit**” is indicated.
2. Press the blue button → to enter the base units selection menu.
The display indicates the present base units on the bottom display line.
3. If these base units are correct, press the red button ↵ to exit to the menu.
(The menu option “**b.unit**” re-appears. Press ↓ to get to the next menu).
4. Press the blue button → to start the editing mode. The base units flash to indicate they can be edited.
5. Press the green button ↓ repeatedly to scroll through the three options.

6. Press the blue button → to confirm the selected base units. (The flashing stops).
7. If the new setting is correct, press the red button ↵ to save.
(The transmitter automatically re-starts as if it was a new instrument on first power-up).
8. If the new setting is incorrect, press the blue button → to exit to the menu.
9. The menu option “**b.unit**” re-appears to re-start at step (2), or press ↓ to exit the “**Eng**” menu and then the blue button → to change to the PV display.

5.5 False echoes under certain ambient operating conditions

In applications where elevated ambient temperatures of around 122 to 140 °F (50 to 60 °C) are experienced, together with poor liquid surface conditions (excessive surface agitation, foam, etc.), the transmitter may see a false echo and report a false high level measurement.

To overcome this issue, the near zone threshold (Threshold 1 Size P048) was changed from software version V4.02 onwards to provide the following duty:

- **Threshold 1 Size P048**

The factory default value of this parameter is **6%** (prior to V4.02 software this had a default value of 4%).

If Threshold 1 Size **P048** is *equal to* 6.0 (default), the transmitter automatically adjusts the value of the initial threshold in use at elevated temperatures to eliminate false high level readings.

If Threshold 1 Size **P048** is *set to* 6.0 **and** Threshold 1 Time **P043** is *equal to* 2.9 (default), the transmitter simultaneously adjusts the value of the initial threshold time in use at higher temperatures.

If Threshold 1 Size **P048** is *not equal to* 6.0, the unit uses that value and Threshold 1 Time **P043** will be as programmed.

Note that operating at elevated ambient temperatures over 140 °F (50 °C) may have an impact on the accuracy of the liquid level reading when the liquid level is within approximately 0.5 m of the transducer face. The accuracy may be reduced from ±2.5 mm to +2.5/-5.5 mm or, in extreme conditions, +2.5/-8.5 mm.

Note

- Parameters P048 and P043 are accessible only when using a Field Communicator or a Mobrey MCU900 Series Control Unit. The main descriptions for these parameters are on pages 137 to 138 in [Appendix F: Configuring Using HART](#).
-

Appendix A Reference Data

Specifications	page 63
Dimension drawings	page 68

A.1 Specifications

A.1.1 General

Products

- Mobrey MSP400RH Ultrasonic Transmitter:
Level, Distance, Content (Volume), and Flow measurement, with two integral signal relays
- Mobrey MSP900GH Ultrasonic Transmitter:
Level, Distance, Content (Volume), and Flow measurement for hazardous locations

Measurement principle

- Ultrasonic, time-of-flight

A.1.2 Measuring performance

Measurement range

- 1 to 36 ft. (0,3 to 11 m)

Blanking distance (dead zone)

- 12 in. (0,3 m)

Level resolution

- Better than 0.06 in. (1 mm)

Level accuracy under reference conditions⁽¹⁾

- ± 0.1 in. (2,5 mm) < 3.3 ft (1 m),
 $\pm 0.25\%$ of measured distance for > 3.3 ft. (1 m)

Update interval

- Display: 500 ms
- Current Output: 200 ms

A.1.3 Display and configuration

Integral display

- 4/5 digit display for live measurement, and for configuration purposes

(1) Temperature: 68 °F (20 °C), Pressure: 1013 mbar (atmospheric pressure), Relative Humidity: 50%, calm and stable water surface.

Output units

- For Level or distance-to-surface: m, ft, in, or none
- For Contents: l, m³, gal, ft³, or none
- For Flow: l/s, l/m, m³/hr, gal/s, gal/m, ft³/m (cfm), ft³/hr, or none

Output variables

- Level (or distance-to-surface), Content (Volume), and Flow

Configuration tools

- Standard integral push-buttons with LCD
- Field Communicator
- Mobrey MCU900 Series Universal Control Unit

A.1.4 Electrical

Power supply

- Loop-powered (two-wire)
- Mobrey MSP400RH: 12 to 40 Vdc
- Mobrey MSP900GH:
12 to 40 Vdc (non-hazardous area),
12 to 30 Vdc (hazardous area)

Earthing

- None required

Current output

- Analog 4–20 mA, HART

Signal on alarm

- Low = 3.6 mA. High = 21 mA

Saturation levels

- Low = 3.8 mA. High = 20.5 mA

Relay output (MSP400RH)

- Two integral signal relays, SPST rated 1A @ 30 Vdc (inductive) and 2A @ 30 Vdc (resistive)

Electrical parameters (MSP900GH)

- $U_i = 30\text{ V}$, $I_i = 120\text{ mA}$, $P_i = 0,82\text{ W}$, $L_i = 108\ \mu\text{H}$, $C_i = 0\text{ nF}$

Cable entry

- Two M20 x 1.5 conduit entries for cable glands

Output cabling

- Single twisted-pair and shielded, min. 0,22 mm² (24 AWG), max. 1,5 mm² (15 AWG)

A.1.5 Physical specifications

Materials selection

- Emerson provides a variety of product with various product options and configurations including materials of construction that can be expected to perform well in a wide range of applications. The product information presented is intended as a guide for the purchaser to make an appropriate selection for the application. It is the purchaser's sole responsibility to make a careful analysis of all process parameters (such as all chemical components, temperature, pressure, flow rate, abrasives, contaminants, etc.), when specifying product, materials, options and components for the particular application. Emerson Process Management is not in a position to evaluate or guarantee the compatibility of the process fluid or other process parameters with the product, options, configuration or materials of construction selected.

Materials used in construction

- Wet-side material: PVDF
- Body and cover material: Glass-filled nylon
- Cover seal: Silicone rubber
- Cover screws: 316 Stainless Steel
- Transducer body seal: EPDM

A.1.6 Mechanical

Mounting thread size

- 2-in. NPT, or 2-in. BSP. Optional flange accessories available

Weight of transmitter

- MSP400RH: 2.2 lb (1,0 kg)
- MSP900GH: 3.1 lb (1,4 kg)

A.1.7 Measuring

Temperature compensation⁽¹⁾

- Automatic Integral temperature compensation.
(Optional remote temperature sensor for dynamic temperature compensation)

(1) See Product Data Sheet for optional accessories.

A.1.8 Environment

Ambient temperature⁽¹⁾

- MSP400RH:
-40 to 158 °F (-40 to 70 °C)
- MSP900GH:
-40 to 140 °F (-40 to 60 °C)

Process temperature

- -22 to 158 °F (-30 to 70 °C)

Process pressure:

- -4 to 44 psi (-0,25 to 3,0 bar)

Ingress protection

- IP 66/67 (when using supplied cable gland/blanking plug)

Electromagnetic compatibility

- EN61326 (Class B)

Certifications

- CE-mark, FM, ATEX (dependent on order code)

Figure A-1. Process temperature and pressure ratings

The process temperature/pressure rating depends on the design of the transmitter in combination with the flange materials.

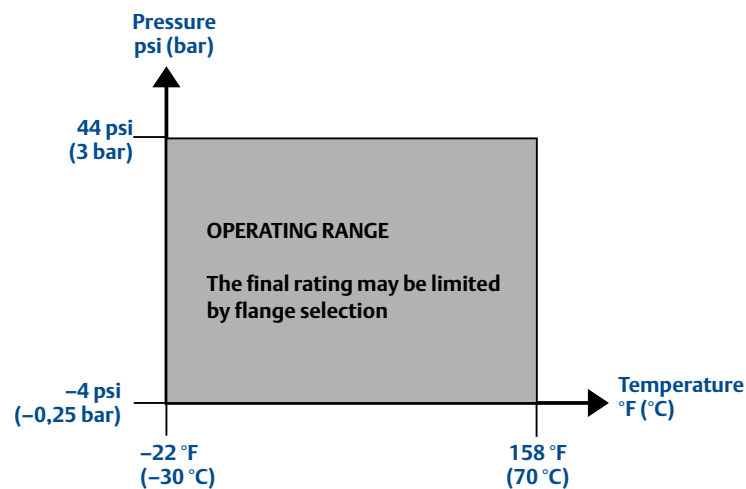

(1) See Appendix B: Product Certifications for approval temperature ranges.

Figure A-2. Load limitations

A Field Communicator requires a minimum load resistance of 250 Ohm within the loop in order to function properly. Communication with Mobrey MCU900 Series Control Unit does not require additional resistance. The maximum load resistance can be determined from these diagrams:

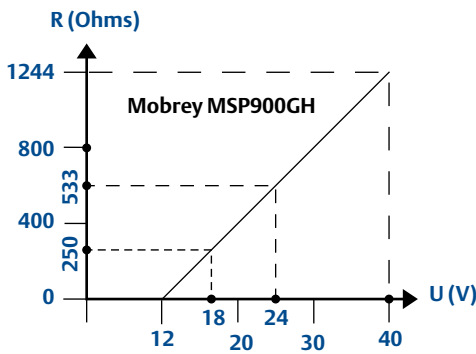
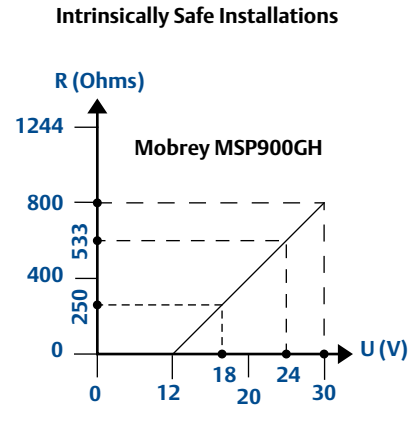
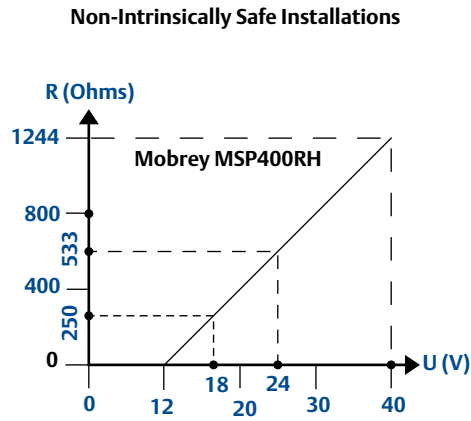

Note:
R = Maximum Load Resistance
U = External Power Supply Voltage

A.2 Dimension drawings

Figure A-3. Transmitter Dimensions (Nylon-filled Glass Housing)

Note: Dimensions are in inches (mm).

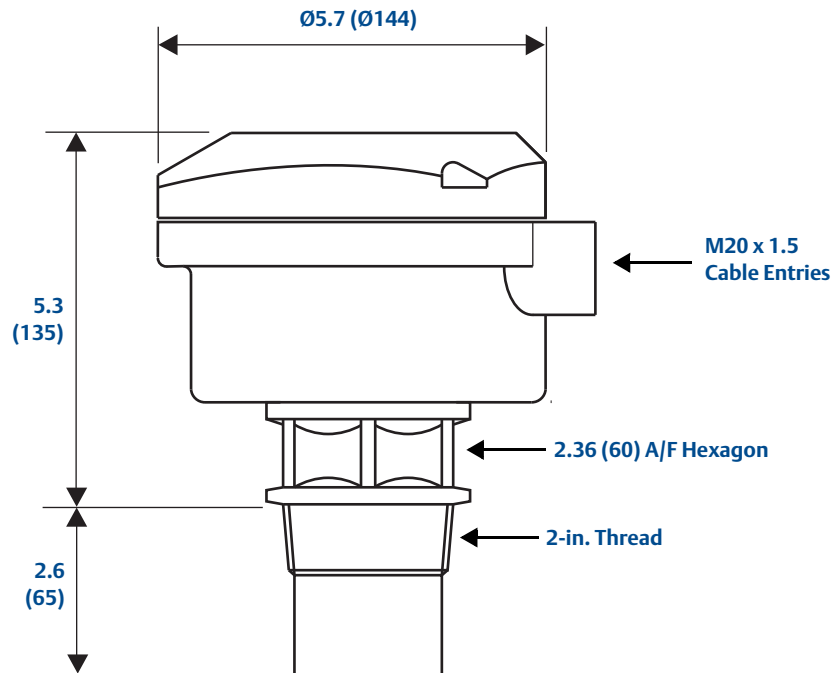
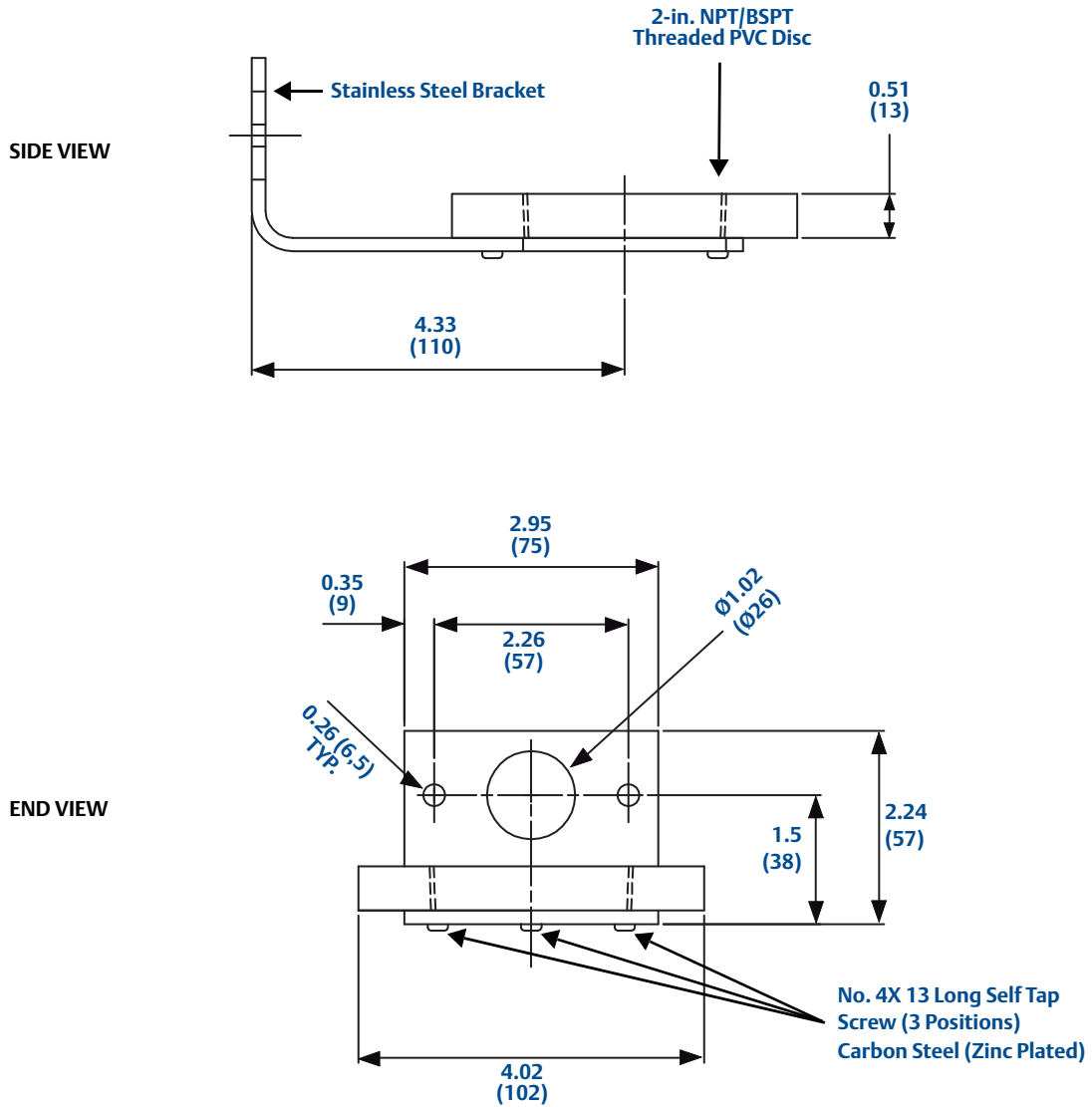

Figure A-4. The 2-in. NPT/BSPT mounting bracket

Note: Dimensions are in inches (mm).

Note: The combined weight of bracket and disc is 16 oz. (0,5 kg).





ACTUAL VIEW WITH TRANSMITTER MOUNTED



Appendix B Product Certifications

Safety messages	page 71
Approved manufacturing location	page 71
European directive information	page 72
Ordinary locations certification (MSP400RH only)	page 72
Hazardous locations certifications (MSP900GH only)	page 72

B.1 Safety messages

Procedures and instructions in this manual may require special precautions to ensure the safety of the personnel performing the operations. Information that raises potential safety issues is indicated by a caution symbol (). The external hot surface symbol () is used when a surface is hot and care must be taken to avoid possible burns. If there is a risk of an electrical shock the () symbol is used. Refer to the safety messages listed at the beginning of each section before performing an operation preceded by this symbol.

WARNING

Failure to follow these installation guidelines could result in death or serious injury.

- Make sure only qualified personnel perform the installation.
- Use the equipment only as specified in this manual. Failure to do so may impair the protection provided by the equipment.

Explosions could result in death or serious injury.

- Verify that the operating environment of the transmitter is consistent with the appropriate hazardous locations certifications.
- Before connecting a HART[®]-based communicator in an explosive atmosphere, make sure the instruments in the loop are installed in accordance with intrinsically safe or non-incendive field wiring practices.

Electrical shock could cause death or serious injury.

- Use extreme caution when making contact with the leads and terminals.

WARNING

Any substitution of non-recognized parts may jeopardize safety. Repair, e.g. substitution of components etc., may also jeopardize safety and is under no circumstances allowed.

B.2 Approved manufacturing location

Rosemount Measurement Limited
– Slough, Berkshire, United Kingdom

B.3 European directive information

A copy of the EC declaration of conformity certificate for the transmitters may be obtained by contacting your local sales office.

ATEX directive (94/9/EC)

- The MSP900GH complies with the ATEX directive

Pressure equipment directive (PED) (97/23/EC)

- The Mobrey MSP400RH and MSP900GH are outside the scope of the PED Directive

Electro magnetic compatibility (EMC) (2004/108/EC)

- EN 61326-1:2006, EN 61326-2.3:2006

B.4 Ordinary locations certification (MSP400RH only)

Note

- Refer to the housing label to identify the approvals for your transmitter.
-

B.4.1 American certification

Factory Mutual (FM) ordinary location approval

The transmitter has been examined and tested to determine that the design meets basic electrical, mechanical, and fire protection requirements by FM, a nationally recognized testing laboratory (NRTL) as accredited by the Federal Occupational Safety and Health Administration (OSHA).

B.5 Hazardous locations certifications (MSP900GH only)

Note

- Transmitters that have the following labels attached have been certified to comply with the requirements of the approval agencies noted.
-

B.5.1 European certification

ATEX intrinsically safe approval (MSP900GH only)

Certificate number: Sira 02ATEX2405X

II 1 G

Ex ia IIC T6 Ga ($T_a = -40$ to 55 °C)

Ex ia IIC T4 Ga ($T_a = -40$ to 60 °C)

Ui = 30 V, Ii = 120 mA, Pi = 0.82 W, Li = 108 μ H, Ci = 0 μ F

ATEX conditions for safe use (MSP900GH-A only)

1. The equipment may be used with flammable gases and vapors with apparatus groups IIA, IIB, and IIC, and with temperature classes T1, T2, T3, T4, T5, and T6.
2. Installation of this equipment shall be carried out by suitably trained personnel, in accordance with the applicable code of practice.
3. The equipment is not intended to be repaired by the user and is to be replaced by an equivalent certified unit. Repairs should only be carried out by the manufacturer or approved repairer.
4. If the equipment is likely to come into contact with *aggressive substances*, it is the responsibility of the user to take *suitable precautions* that prevent it from being adversely affected, thus ensuring that the type of protection is not compromised.

Aggressive Substances e.g. acidic liquids or gases that may attack metals or solvents that may affect polymeric materials.

Suitable Precautions e.g. regular checks as part of routine inspections or establishing from the material's data sheet that it is resistant to specific chemicals.

The metallic alloy used for the enclosure material may be accessible at the surface of this equipment. In the event of rare accidents, ignition sources due to impact and friction spark could occur. This shall be considered when the Mobrey MSP900GH is installed in locations that specifically require zone 0 equipment.
5. The apparatus electronics is only certified for use in ambient temperatures in the range of -40 to 60 °C for T4 or -40 to 55 °C for T6. It should not be used outside this range.
6. It is the responsibility of the user to ensure:
 - a. That only suitably certified cable entry devices will be utilized when connecting this equipment.
 - b. That any unused cable entries are sealed with suitably certified stopping plugs.
7. Technical Data:
 - a. Materials of construction:
Probe: PVDF
Housing and cover: glass-filled nylon
Lid seal: Silicone
Nylon cable glands and blanking plugs
 - b. Coding: II 1 G, Ex ia IIC T4 Ga ($T_a = -40$ to 60 °C), Ex ia IIC T6 Ga ($T_a = -40$ to 55 °C)
 - c. Electrical: $U_i = 30$ V, $I_i = 120$ mA, $P_i = 0.82$ W, $L_i = 108$ μ H, $C_i = 0$ μ F
8. Special conditions for safe use:
 - a. The equipment must not be installed directly in any process where the enclosure might be charged by the rapid flow of non-conductive media.
 - b. The equipment must only be cleaned with a damp cloth.
9. Manufacturer: Rosemount Measurement Limited, 158 Edinburgh Avenue, Slough, Berkshire, SL1 4UE, UK

Appendix C Integrated Display Menus

Main menu map	page 76
Diagnostics menu map	page 78
Engineering menu map	page 79

C.1 Main menu map

Figure C-1. Main menu programming

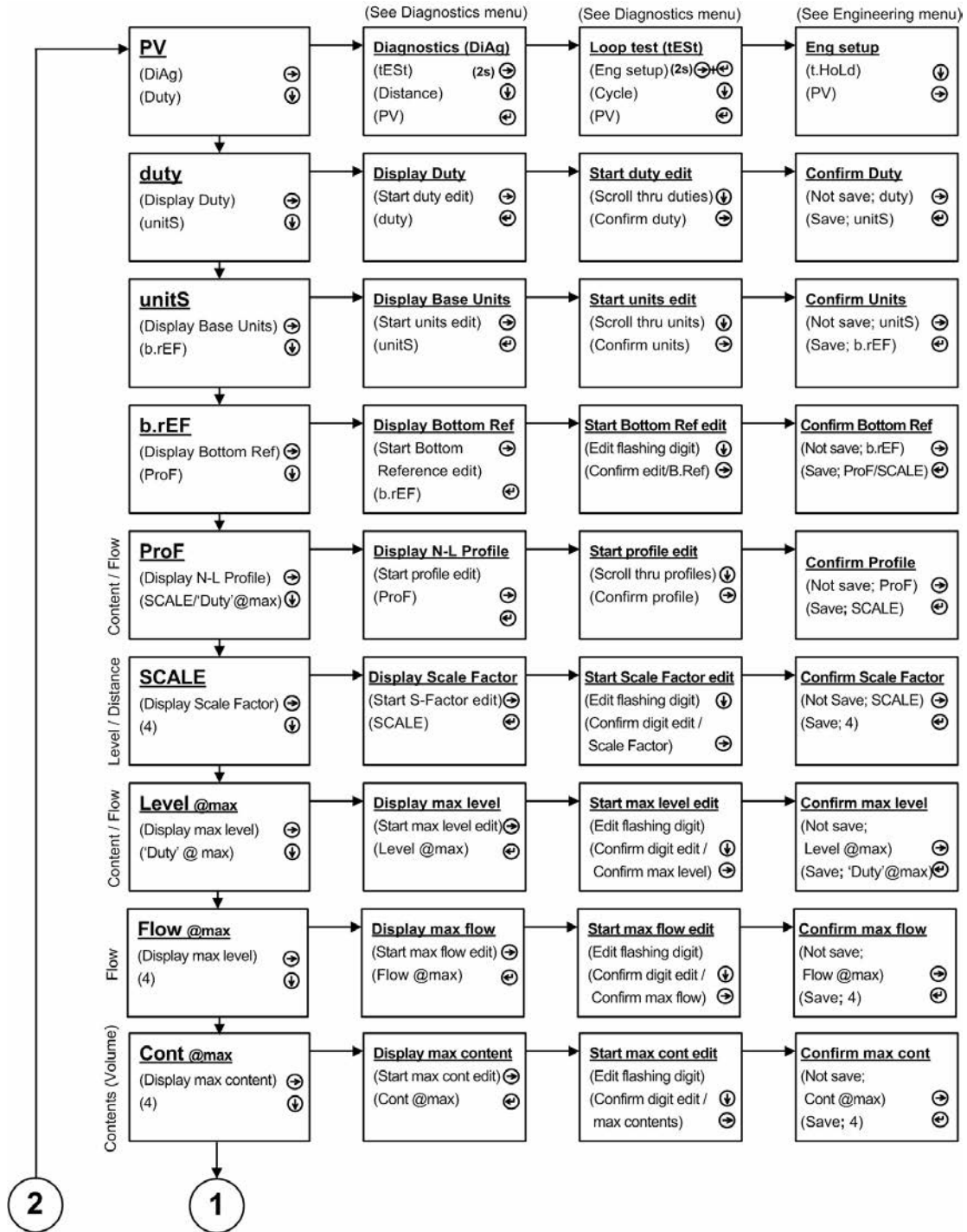

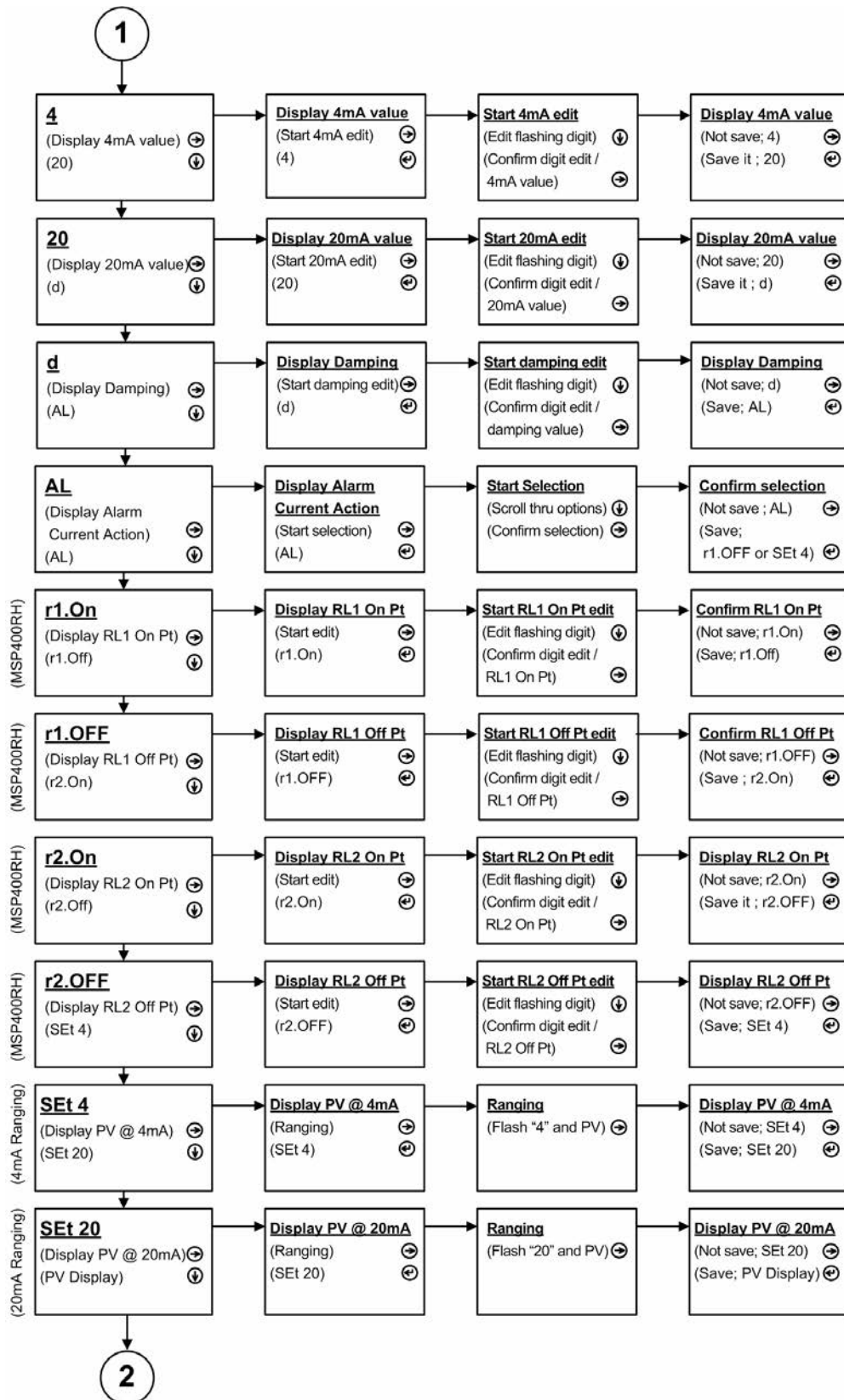

C.2 Diagnostics menu map

Figure C-2. Diagnostics menu

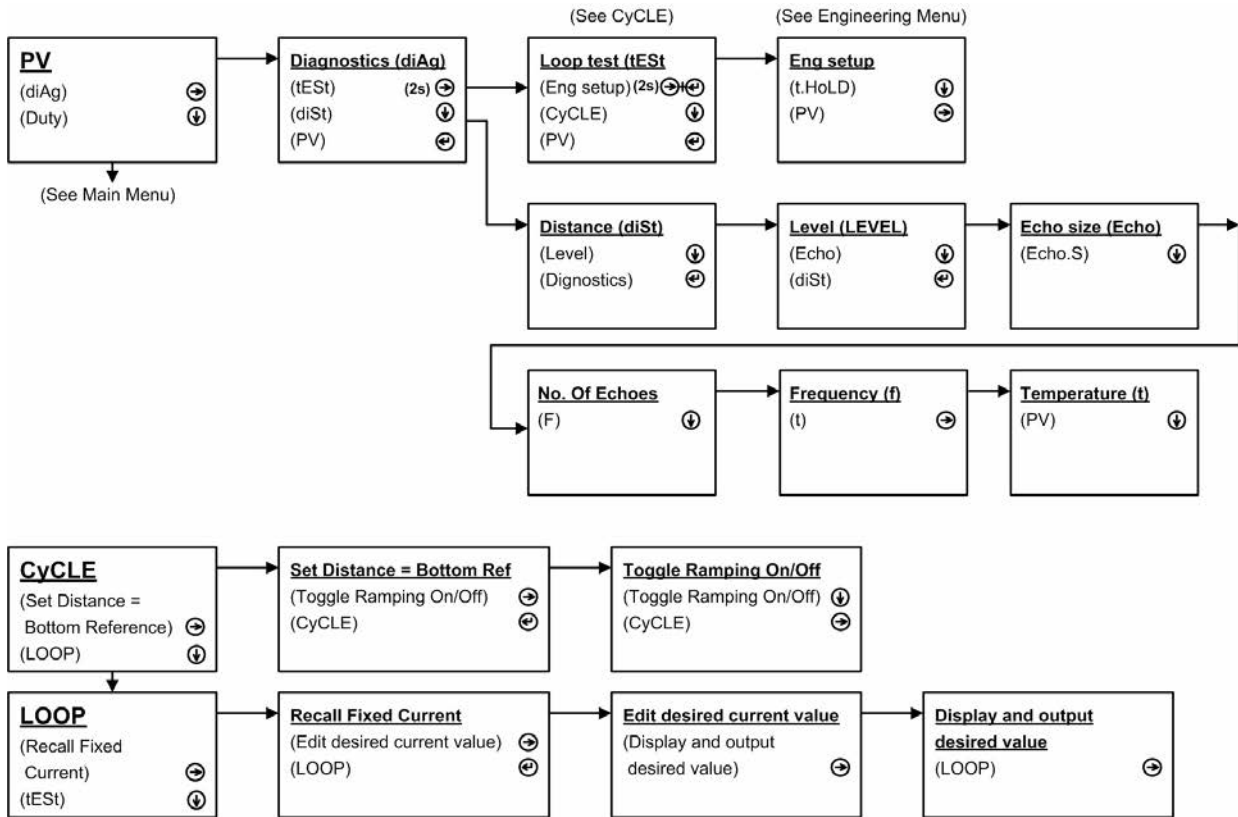

C.3 Engineering menu map

Figure C-3. Engineering menu

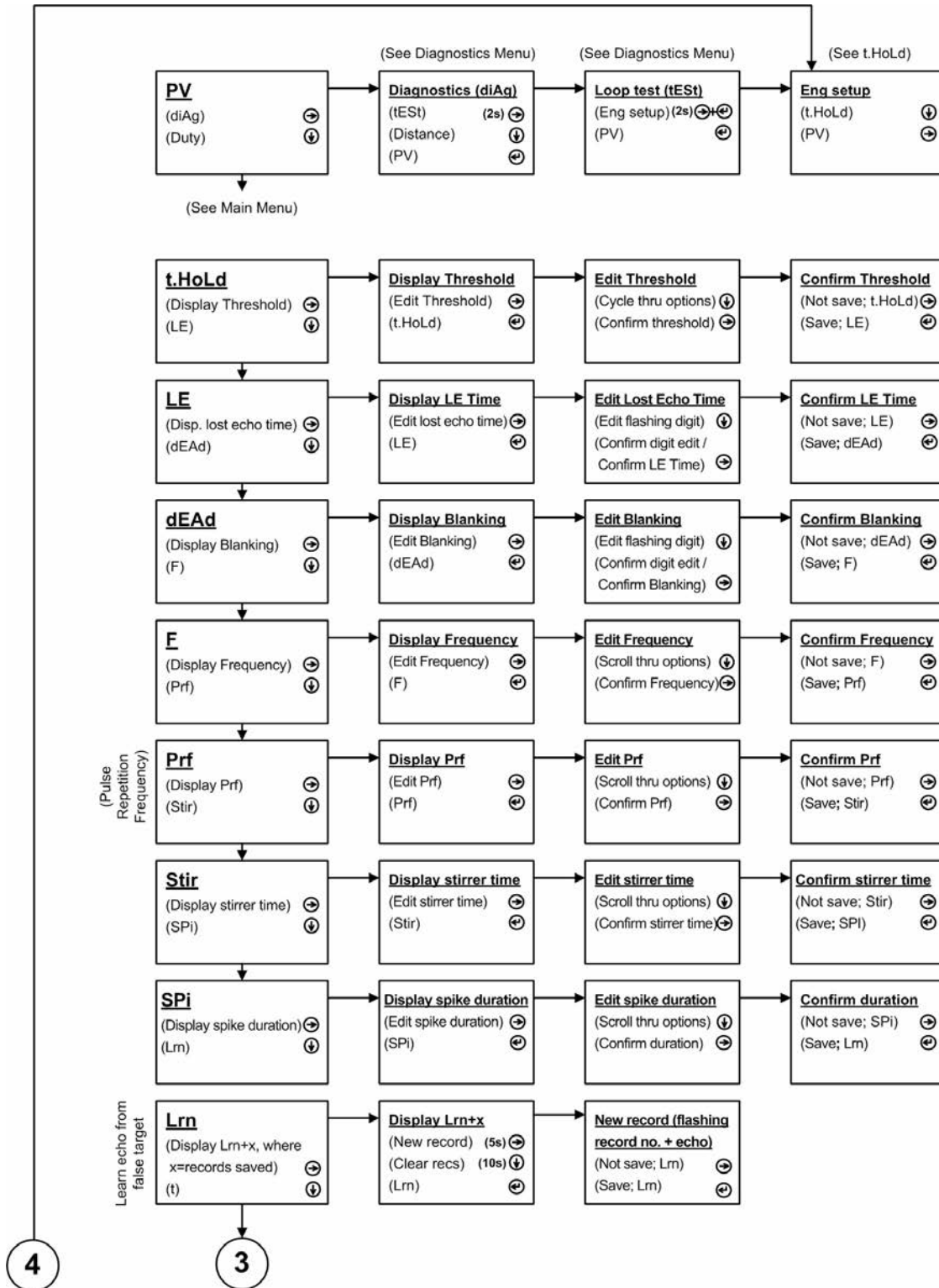

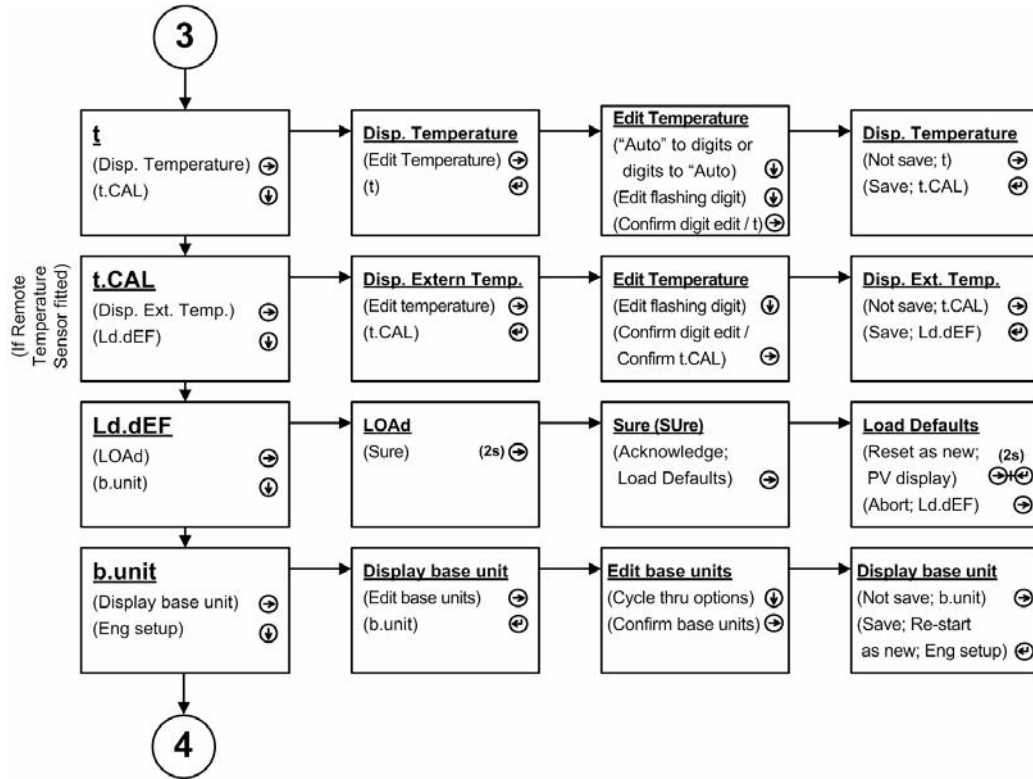

Appendix D Mobrey MCU900 Series

D.1 Introduction

The MSP400RH and MSP900GH can be used with the Mobrey MCU900 Series control unit. This control unit supplies the 24 Vdc loop-power to the transmitter, and provides control functionality using the 4–20 mA signal from the transmitter.

The control unit has HART communications capability, and access to all of the parameters of the transmitter as shown in [Table D-1 on page 82](#).

Table D-1. Mobrey MSP400RH and MSP900GH transmitter menus and parameters on a MCU900 Series control unit

Menu Level 1	Menu Level 2	Menu Level 3	Menu Level 4	Parameter ID and Descriptor	Units	MSP400RH			MSP900GH							
						m	ft.	in.	m	ft.	in.					
SETUP (1)	DUTY			P010	Bottom Reference (page 105)	(2)	11.0	36.0	432.0	11.0	36.0	432.0				
					Present Depth (page 92)	(2)	-	-	-	-	-	-	-			
					SET AS EMPTY (page 91)	-	-	-	-	-	-	-	-	-		
				P011	Tank Shape (page 111)	-	-	-	-	-	-	-	-	-		
						-	-	-	-	-	-	-	-	-		
				P060	Distance Offset (page 109)	(2)	0.0	0.0	0.0	0.0	0.0	0.0	0.0	0.0		
				P069	Level Offset (page 110)	(2)	0.0	0.0	0.0	0.0	0.0	0.0	0.0	0.0		
				P013	PV Scale Factor (page 121)	-	1.0	1.0	1.0	1.0	1.0	1.0	1.0	1.0		
				P014	Profile Height (page 122)	(2)	1.0	1.0	1.0	1.0	1.0	1.0	1.0	1.0		
				P030	Profile Point 1 (page 124)	%	10	10	10	10	10	10	10	10		
				P031	Profile Point 2 (page 124)	%	20	20	20	20	20	20	20	20		
				P032	Profile Point 3 (page 124)	%	30	30	30	30	30	30	30	30		
				P033	Profile Point 4 (page 124)	%	40	40	40	40	40	40	40	40		
				P034	Profile Point 5 (page 124)	%	50	50	50	50	50	50	50	50		
				P035	Profile Point 6 (page 124)	%	60	60	60	60	60	60	60	60		
				P036	Profile Point 7 (page 124)	%	70	70	70	70	70	70	70	70		
				P037	Profile Point 8 (page 124)	%	80	80	80	80	80	80	80	80		
				P038	Profile Point 9 (page 124)	%	90	90	90	90	90	90	90	90		
				P039	Profile Point 10 (page 124)	%	100	100	100	100	100	100	100	100		
				P000	Message (page 101)	-	-	-	-	-	-	-	-	-	MESSAGE	
				P001	Tag (page 102)	-	-	-	-	-	-	-	-	-	MESSAGE	
				P002	Description (page 102)	-	-	-	-	-	-	-	-	-	MESSAGE	
				UNITS	OUTPUT			P012	PV Units (page 120)	-	m	ft	in	m	ft	in
								P015	Upper Range Value (page 125)	(2)	10.7	34.5	414.0	10.7	34.5	414.0
								P016	Lower Range Value (page 126)	(2)	0.0	0.0	0.0	0.0	0.0	0.0
								P020	Damping (page 127)	sec	3.0	3.0	3.0	3.0	3.0	3.0
P070	Relay 1 mode (page 128)	-	-					-	-	-	-	-	-	-		
P071	Relay 1 PV On Point (page 128)	(2)	0.0					0.0	0.0	0.0	0.0	0.0	0.0	0.0		
P072	Relay 1 PV Off Point (page 128)	(2)	0.0					0.0	0.0	0.0	0.0	0.0	0.0	0.0		
P073	Relay 2 mode (page 128)	-	-					-	-	-	-	-	-	-		
P074	Relay 2 PV On Point (page 128)	(2)	0.0					0.0	0.0	0.0	0.0	0.0	0.0	0.0		
P075	Relay 2 PV Off Point (page 128)	(2)	0.0					0.0	0.0	0.0	0.0	0.0	0.0	0.0		
P021	LE Delay (page 128)	sec	900					900	900	900	900	900	900	900		
P022	LE Action (page 130)	-	Hold					Hold	Hold	Hold	Hold	Hold	Hold	Hold		
P023	Upper Blanking (page 107)	(2)	0.3					1.0	12	0.3	1.0	12	0.3	1.0		
P063	Lower Blanking (page 108)	(2)	0.0	0.0	0.0	0.0	0.0	0.0	0.0	0.0						
P024	Speed of Sound (page 131)	m ft in/s	331.8	1088.6	13063	331.8	1088.6	13063	331.8	1088.6	13063					
P025	Temperature (page 132)	°C or °F	Auto	Auto	Auto	Auto	Auto	Auto	Auto	Auto	Auto					
P026	Set Threshold (page 133)	%	Auto	Auto	Auto	Auto	Auto	Auto	Auto	Auto	Auto					
ENGINEERING				P000	Message (page 101)	-	-	-	-	-	-	MESSAGE				
				P001	Tag (page 102)	-	-	-	-	-	-	-	-	MESSAGE		
				P002	Description (page 102)	-	-	-	-	-	-	-	-	MESSAGE		
				P012	PV Units (page 120)	-	m	ft	in	m	ft	in	m	ft	in	
				P015	Upper Range Value (page 125)	(2)	10.7	34.5	414.0	10.7	34.5	414.0	10.7	34.5	414.0	
				P016	Lower Range Value (page 126)	(2)	0.0	0.0	0.0	0.0	0.0	0.0	0.0	0.0	0.0	
				P020	Damping (page 127)	sec	3.0	3.0	3.0	3.0	3.0	3.0	3.0	3.0	3.0	
				P070	Relay 1 mode (page 128)	-	-	-	-	-	-	-	-	-	-	
				P071	Relay 1 PV On Point (page 128)	(2)	0.0	0.0	0.0	0.0	0.0	0.0	0.0	0.0	0.0	
				P072	Relay 1 PV Off Point (page 128)	(2)	0.0	0.0	0.0	0.0	0.0	0.0	0.0	0.0	0.0	
				P073	Relay 2 mode (page 128)	-	-	-	-	-	-	-	-	-	-	
				P074	Relay 2 PV On Point (page 128)	(2)	0.0	0.0	0.0	0.0	0.0	0.0	0.0	0.0	0.0	
				P075	Relay 2 PV Off Point (page 128)	(2)	0.0	0.0	0.0	0.0	0.0	0.0	0.0	0.0	0.0	
P021	LE Delay (page 128)	sec	900	900	900	900	900	900	900	900	900					
P022	LE Action (page 130)	-	Hold	Hold	Hold	Hold	Hold	Hold	Hold	Hold	Hold					
P023	Upper Blanking (page 107)	(2)	0.3	1.0	12	0.3	1.0	12	0.3	1.0	12					
P063	Lower Blanking (page 108)	(2)	0.0	0.0	0.0	0.0	0.0	0.0	0.0	0.0	0.0					
P024	Speed of Sound (page 131)	m ft in/s	331.8	1088.6	13063	331.8	1088.6	13063	331.8	1088.6	13063					
P025	Temperature (page 132)	°C or °F	Auto	Auto	Auto	Auto	Auto	Auto	Auto	Auto	Auto					
P026	Set Threshold (page 133)	%	Auto	Auto	Auto	Auto	Auto	Auto	Auto	Auto	Auto					

Menu Level 1	Menu Level 2	Menu Level 3	Menu Level 4	Parameter ID and Descriptor	Units	MSP400RH			MSP900GH		
						m	ft.	in.	m	ft.	in.
		ADVANCED		P040 Tx Pwr Control (page 135)	-		Enabled		Enabled		
				P041 Pulse Repeat (page 136)	sec	1.0	1.0	1.0	1.0	1.0	1.0
				P042 Echoes Needed (page 136)	%	4	4	4	4	4	4
				P043 Threshold 1 Time (page 137)	ms	2.9	2.9	2.9	2.9	2.9	2.9
				P044 Target Pulses (page 139)	-	Auto	Auto	Auto	Auto	Auto	Auto
				P045 Target frequency (page 140)	kHz	Auto	Auto	Auto	Auto	Auto	Auto
				P048 Threshold 1 Size (page 138)	%	6.0	6.0	6.0	6.0	6.0	6.0
				P049 Spike Rejection (page 141)	-	0	0	0	0	0	0
				P081 False Echo D 1 (page 142)	(2)	0.0	0.0	0.0	0.0	0.0	0.0
				P082 False Echo S 1 (page 142)	%	0.0	0.0	0.0	0.0	0.0	0.0
				P083 False Echo D 2 (page 142)	(2)	0.0	0.0	0.0	0.0	0.0	0.0
				P084 False Echo S 2 (page 142)	%	0.0	0.0	0.0	0.0	0.0	0.0
				P085 False Echo D 3 (page 142)	(2)	0.0	0.0	0.0	0.0	0.0	0.0
				P086 False Echo S 3 (page 142)	%	0.0	0.0	0.0	0.0	0.0	0.0
				P087 False Echo D 4 (page 142)	(2)	0.0	0.0	0.0	0.0	0.0	0.0
				P088 False Echo S 4 (page 142)	%	0.0	0.0	0.0	0.0	0.0	0.0
				D980 No. of false echoes stored	-	-	-	-	-	-	-
				P089 Clear False Echoes (page 143)	-	-	-	-	-	-	-
				LEARN FALSE ECHO (page 93)	-	-	-	-	-	-	-
				AUTO TANK MAP (page 94)	-	-	-	-	-	-	-
				SIMULATION (page 95)	-	-	-	-	-	-	-
				FIX CURRENT (page 98)	-	-	-	-	-	-	-
				TRIM 4 mA (page 99)	-	-	-	-	-	-	-
				TRIM 20 mA (page 99)	-	-	-	-	-	-	-
				RESTART DEVICE (page 96)	-	-	-	-	-	-	-
				LOAD DEFAULTS (page 97)	-	-	-	-	-	-	-
				FACTORY USE	-	-	-	-	-	-	-
				Base Units (page 90)	-	-	-	-	-	-	-
				P004 Final Assy No. (page 103)	-		(Factory Set)		(Factory Set)		(Factory Set)
				P005 Serial Number (page 104)	-		(Factory Set)		(Factory Set)		(Factory Set)
				P970 Transducer Material (page 144)	-		PVDF		PVDF		PVDF
				D949 Model Code (page 163)	-		(Factory Set)		(Factory Set)		(Factory Set)
				D951 Poll Address (page 144)	-		0		0		0
				D952 Hardware Revision (page 163)	-		(Factory Set)		(Factory Set)		(Factory Set)
				D953 Software Revision (page 164)	-		(Factory Set)		(Factory Set)		(Factory Set)
				D960 Manufacturer (page 165)	-		Mobrey		Mobrey		Mobrey
				D961 Unique ID (page 165)	-		(Factory Set)		(Factory Set)		(Factory Set)
				D962 HART Revision (page 166)	-	5	5	5	5	5	5
				D963 Field Device Rev. (page 167)	-		(Factory Set)		(Factory Set)		(Factory Set)
				D964 Request Preambles (page 167)	-	5	5	5	5	5	5
				D965 Flags (page 168)	-	-	-	-	-	-	-

Menu Level 1	Menu Level 2	Menu Level 3	Menu Level 4	Parameter ID and Descriptor	Units	MSP400RH			MSP900GH				
						m	ft.	in.	m	ft.	in.		
MONITOR ⁽¹⁾	READINGS	VARIABLES		D900	Primary Variable (page 147)	As P012	-	-	-	-	-	-	
				D901	Level (SV) (page 148)	⁽²⁾	-	-	-	-	-	-	
	D902	Distance (TV) (page 149)	⁽²⁾	-	-	-	-	-	-	-			
	D903	Temperature (page 150)	°C or °F	-	-	-	-	-	-	-	-		
	D906	Current Output (page 152)	mA	-	-	-	-	-	-	-	-		
	D905	% Current Output (page 151)	%	-	-	-	-	-	-	-	-		
	D908	Relay Status ⁽³⁾	-	-	-	-	-	-	-	-	-		
	D910	Distance (page 153)	⁽²⁾	-	-	-	-	-	-	-	-		
DIAGNOSTICS				D911	Echo Size (page 154)	%	-	-	-	-	-	-	
				D912	Echo Success (page 155)	%	-	-	-	-	-	-	-
				D913	Target Echoes (page 156)	-	-	-	-	-	-	-	-
				D914	Speed Of Sound (page 157)	m ft in/s	-	-	-	-	-	-	-
				D915	Temperature SoS calc (page 158)	°C or °F	-	-	-	-	-	-	-
				D916	Frequency (page 159)	kHz	-	-	-	-	-	-	-
				D917	Threshold in Use (page 160)	%	-	-	-	-	-	-	-
				D918	Pulses in Use (page 161)	-	-	-	-	-	-	-	-
				D919	Transmit Power (page 162)	-	-	-	-	-	-	-	-
				P003	Date (page 146)	-	-	-	-	-	-	-	-
				P046	Max Temperature (page 145)	-	-	-	-	-	-	-	-
				P047	Min Temperature (page 146)	-	-	-	-	-	-	-	-
				D991	Device Status Group 1	-	-	-	-	-	-	-	-
				D992	Device Status Group 2	-	-	-	-	-	-	-	-
				D993	Device Status Group 3	-	-	-	-	-	-	-	-
				D994	Device Status Group 4	-	-	-	-	-	-	-	-
D995	Device Status Group 5	-	-	-	-	-	-	-	-				
D996	Device Status Group 6	-	-	-	-	-	-	-	-				
OPERATION				D915	Temperature SoS calc (page 158)	°C or °F	-	-	-	-	-		
				D916	Frequency (page 159)	kHz	-	-	-	-	-	-	
				D917	Threshold in Use (page 160)	%	-	-	-	-	-	-	
				D918	Pulses in Use (page 161)	-	-	-	-	-	-	-	
HISTORY				P003	Date (page 146)	-	-	-	-	-			
				P046	Max Temperature (page 145)	-	-	-	-	-			
STATUS ⁽⁴⁾				D991	Device Status Group 1	-	-	-	-	-			
				D992	Device Status Group 2	-	-	-	-	-			
				D993	Device Status Group 3	-	-	-	-	-			
				D994	Device Status Group 4	-	-	-	-	-			

(1) Selecting this menu presents a SELECT INSTRUMENT screen if a HART transmitter is assigned to a Current Input channel. Select TRANSMITTER tag to see Menu Level 1 options.

(2) Units are the same as PV Units selection.

(3) Available on the MSP400RH only.

(4) These parameters are used by AMS Device Suite.

Appendix E Field Communicator

Introduction	page 85
Safety messages	page 85

E.1 Introduction

The MSP400RH and MSP900GH support HART communications, which may be used to program or interrogate the transmitter from any point on the two-wire loop. This appendix contains the full menu structure.

E.2 Safety messages

Procedures and instructions in this section may require special precautions to ensure the safety of the personnel performing the operations. Information that raises potential safety issues is indicated by a warning symbol (⚠). Please refer to the following safety messages before performing an operation preceded by this symbol.

⚠ WARNING

Failure to follow these installation guidelines could result in death or serious injury.

- Make sure only qualified personnel perform the installation.
- Use the equipment only as specified in this manual. Failure to do so may impair the protection provided by the equipment.

Explosions could result in death or serious injury.

- Verify that the operating environment of the transmitter is consistent with the appropriate hazardous locations certifications.
- Before connecting a HART[®]-based communicator in an explosive atmosphere, make sure the instruments in the loop are installed in accordance with intrinsically safe or non-incendive field wiring practices.

Electrical shock could cause death or serious injury.

- Use extreme caution when making contact with the leads and terminals.

Figure E-1. Field Communicator menu tree

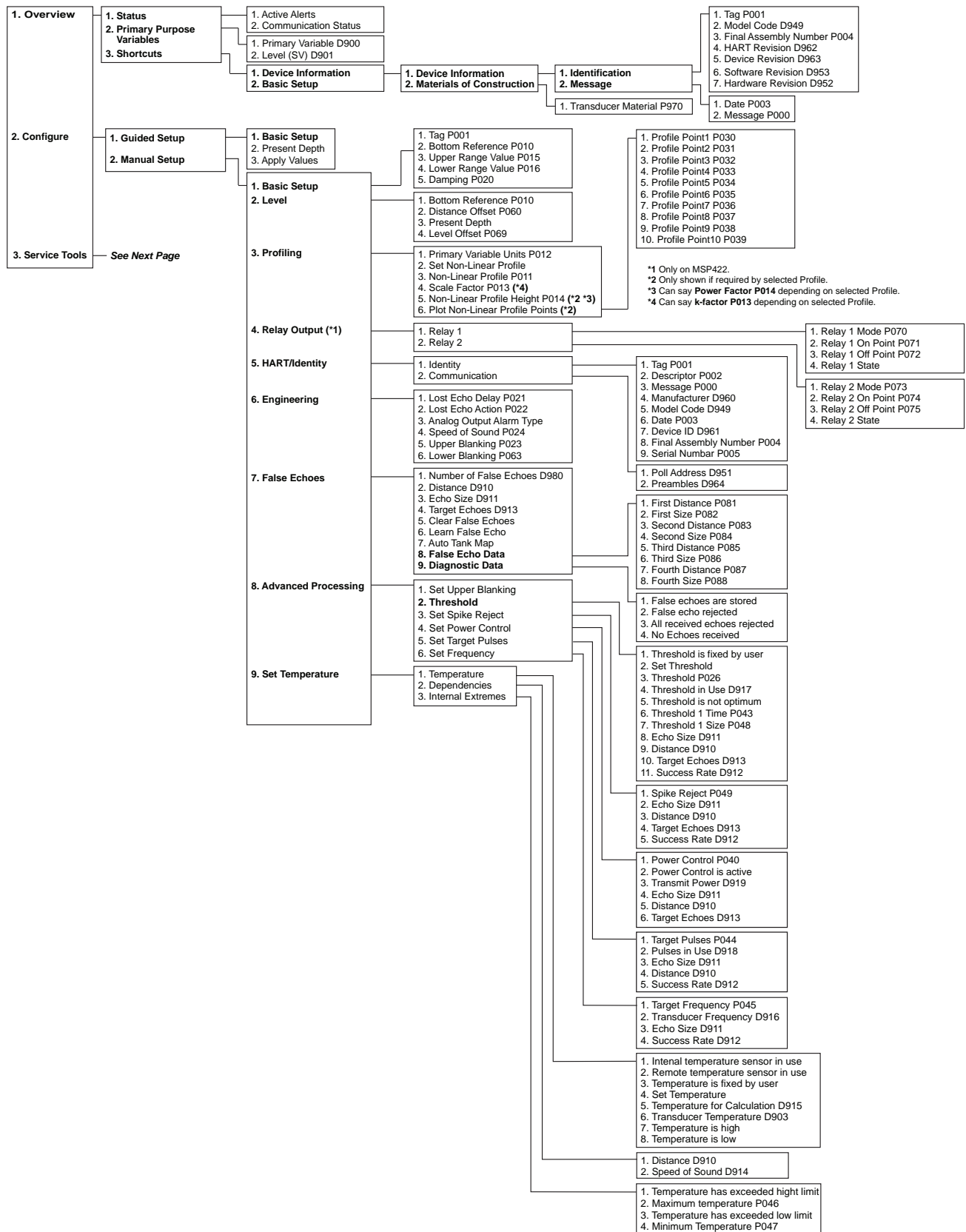

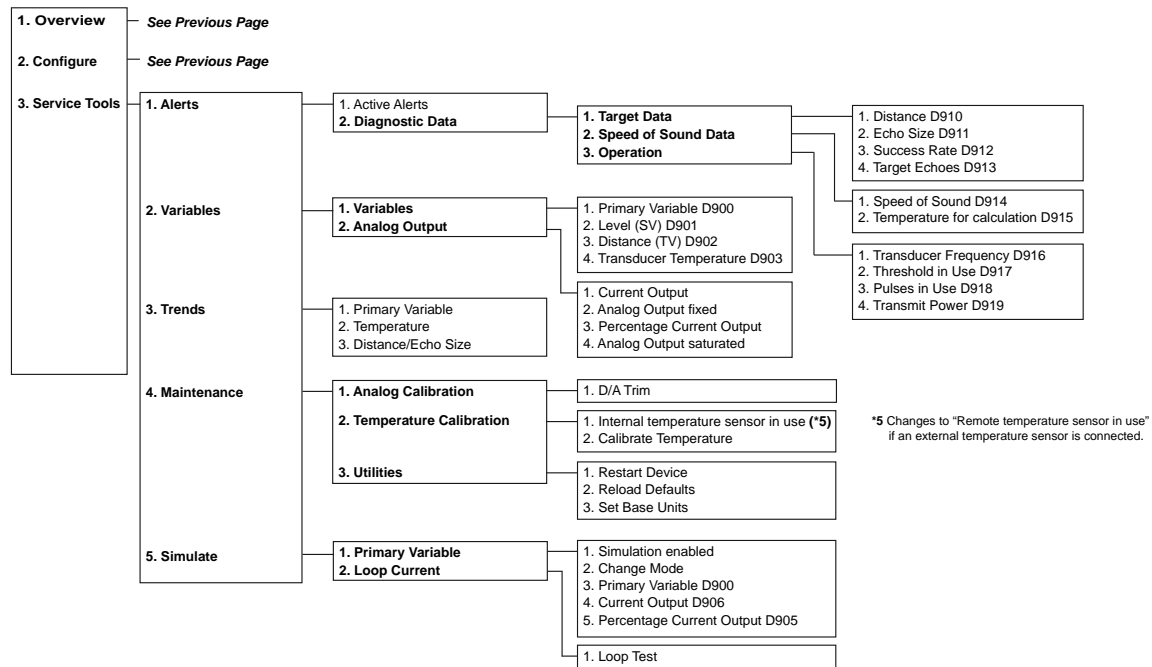

Appendix F Configuring Using HART

Overview	page 89
Command parameters	page 90
Configuration parameters	page 101
Monitoring and diagnostic parameters	page 147

F.1 Overview

The MSP400RH and MSP900GH support HART communications, which may be used to program or interrogate the transmitters from any point on the two-wire loop. This section contains information on configuring the transmitters using a Field Communicator or a Mobrey MCU900 Series Control Unit.

Mobrey MCU900 Series Control Unit

The product reference manual (IP2030/RM) provides full instructions on installation and operation of the control unit. There is also a quick installation guide (IP2030/QS). Both of these product documents are available in the Adobe PDF format, and can be downloaded from the Mobrey brand pages at www.emersonprocess.com.

A full menu map showing how to access transmitter parameters using the control unit's menu system is in [Appendix D: Mobrey MCU900 Series](#). For convenience, the parameter identification numbers (P*** and D***) are used in parameter headings and descriptions in this appendix.

When using the control unit, use the **Enter** (↵) key to start editing a configuration parameter and then use the arrow keys to change the setting. Changes are confirmed by pressing the **Enter** key, or abandoned by pressing the **Esc** key. Commands e.g. **Set As Empty** are run using the **Enter** (↵) key.

Field communicator

For convenience, Field Communicator fast key sequences are labeled “Fast Keys” for each software function below the appropriate headings. A full menu map showing how to access transmitter parameters using the Field Communicator is in [Appendix E: Field Communicator](#).

Example software function

Fast Keys	1, 2, 3, etc.
-----------	---------------

When using a Field Communicator, some configuration changes are sent to the transmitter by pressing “SEND”.

Connect the Field Communicator leads to the transmitter, and turn on the Field Communicator by pressing the ON/OFF key. The Field Communicator will search for a HART-compatible device and indicate when the connection is made. If the Field Communicator fails to connect, it indicates that no device was found. If this occurs, check the lead connections and re-try.

F.2 Command parameters

F.2.1 Base units

Fast keys	3, 4, 3, 3
-----------	------------

When the transmitter is shipped from the factory, the default factory setting for **Base Units** is “**metric**” or “**imperial ft**” depending on the model order code (see Product Data Sheet IP2045 for ordering information).

Note

- **Keep a record of your programmed settings. Changing base units resets parameters to their default factory settings in the appropriate units.**

Field Communicator

To view or change the transmitter base units:

1. From the *Home* screen, select **3: Service Tools**.
2. Select **4: Maintenance**.
3. Select **3: Utilities**, and then **3: Set Base Units**.
4. Use the up and down navigation keys to select new base units, and then save the selection by pressing “**ENTER**”.
5. Press “**ENTER**” to select **1: Yes** (in response to “**Are you sure?**”).
6. Use the left navigation key to return to the previous menu.

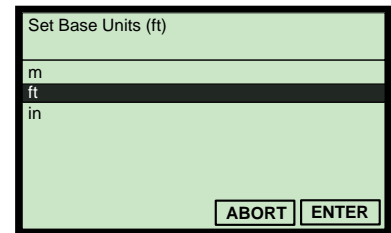

(Field Communicator Screen)

Note

- When messages appear, take appropriate action if needed and press “**OK**”.

Mobrey MCU900 Series control unit

To view or change the transmitter base units:

1. From the *Main Menu* screen, select **SETUP**.
2. Select the transmitter (e.g. “**Tx1 : MSP400RH**”).
3. Select **SYSTEM**, and then **Base Units**.
4. Follow on-screen instructions to select and confirm the new base units.
5. Select “**Quit**” to exit to the previous menu.
6. To get the same base units on the control unit, switch the power off and then on again. The control unit prompts for the transmitter’s **Bottom Reference** value (page 105) in the new base units.

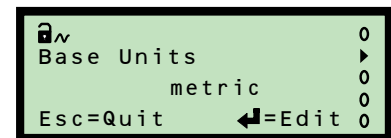

(Mobrey MCU901 Screen)

Note

- The display (reported) units of the transmitter’s process value (PV) can be changed to *metric* or *imperial* measurement units using the parameter **Primary Variable Units** (page 120). However, this does not automatically re-scale the PV. Use the parameter **PV Scale Factor** (page 121) to manually re-scale the value.

F.2.2 Set as empty

Fast Keys	2, 2, 2, 3, 2
------------------	---------------

If the bottom reference is *unknown* and the tank is *empty*, the transmitter can change the **Bottom Reference** value to the **Distance** measurement with the tank empty.

$$P010 = (D910 - P060)$$

Where:

- P010 = Bottom Reference setting (see page 105).
- D910 = Distance measurement (see page 153).
- P060 = Distance Offset setting (see page 109).

Field Communicator

To select the Set As Empty command:

1. From the *Home* screen, select **2: Configure**.
2. Select **2: Manual Setup**.
3. Select **2: Level.**, and then **3: Present Depth**.
4. Select **2: Set as Empty**, and then press “ENTER”.

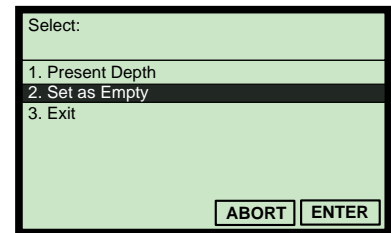

(Field Communicator Screen)

Note

- When messages appear, take appropriate action if needed and press “OK”.
- The command **Set As Empty** is also at Fast Key sequence 2, 1, 2.

Mobrey MCU900 Series control unit

To select the Set As Empty command:

1. From the *Main Menu* screen, select **SETUP**.
2. Select the transmitter (e.g. “Tx1:MSP400RH”).
3. Select **DUTY**, and then **SET AS EMPTY**.
4. Follow on-screen instructions to perform the Set As Empty action. (If prompted to change the mode to off-line, press the **Enter** key).
5. Select “Quit” to exit to the previous menu.

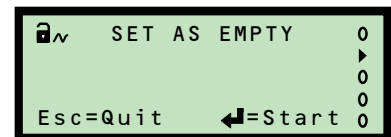

(Mobrey MCU901 Screen)

F.2.3 Present depth

Fast Keys	2, 2, 2, 3, 1
-----------	---------------

If the Bottom Reference is *unknown* but the present liquid depth is *known*, the transmitter can set the **Bottom Reference** value using the **Present Depth** value, the live **Distance** measurement, and optional offsets:

$$P010 = (\text{Depth} + D910) - (P060 + P069)$$

Where:

P010= Bottom Reference (see [page 105](#)).

Depth= Present Depth setting (live level value snapshot but can be edited).

D910= Distance measurement (see [page 153](#)).

P060= Distance Offset (see [page 109](#)).

P069= Level Offset (see [page 110](#)).

Field Communicator

To use the Present Depth feature:

- From the *Home* screen, select **2: Configure**.
- Select **2: Manual Setup**.
- Select **2: Level**, and then **3: Present Depth**.
- Select **1: Present Depth**, and then press “**ENTER**”.
- Follow the on-screen instructions to input the present depth, which will then change the transmitter’s bottom reference using the above **P010** calculation.
- Press “**ENTER**” to confirm the input present depth.

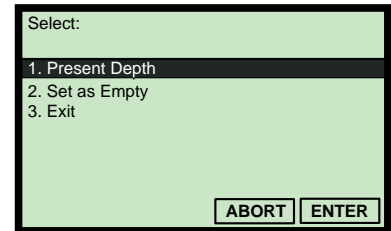

(Field Communicator Screen)

Note

- When messages appear, take appropriate action if needed and press “**OK**”.
- The feature **Present Depth** is also at Fast Key sequence 2, 1, 2.

Mobrey MCU900 Series control unit

To select the Set As Empty command:

- From the *Main Menu* screen, select **SETUP**
- Select the transmitter (e.g. “**Tx1:MSP400RH**”).
- Select **DUTY**, and then **Present Depth**.
- Follow the on-screen instructions to input the present depth, which will then change the transmitter’s bottom reference using the calculation.
(If prompted to change the mode to “off-line”, press the **Enter** key).
- Select “**Quit**” to exit to the previous menu.

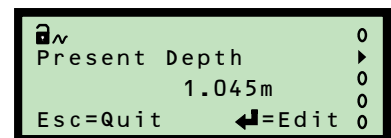

(Mobrey MCU901 Screen)

F.2.4 Learn false echo

Fast Keys	2, 2, 6 [or 7], 6
------------------	-------------------

The transmitter can be manually told the live **Distance** (on page 153) is being calculated from a *false target echo* and that echo can therefore be ignored. If there is another false target echo, repeat the learning process again. A maximum of **four** false echoes can be learnt.

Field Communicator

To ignore a false target echo:

- From the *Home* screen, select **2: Configure**.
- Select **2: Manual Setup**.
- Select **6: False Echoes** (*MSP900GH*) or **7: False Echoes** (*MSP400RH*).
- Select **6: Learn False Echo**.
- Wait three seconds while the transmitter learns to ignore the false echo.

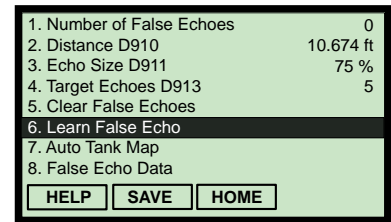

(Field Communicator Screen)

Note

- When messages appear, take appropriate action if needed and press “OK”.

Mobrey MCU900 Series control unit

To ignore a false target echo:

- From the *Main Menu* screen, select **SETUP**.
- Select the transmitter (e.g. “Tx1:MSP400RH”).
- Select **ENGINEERING**.
- Select **FALSE ECHO ACTION**, and then **Learn False Echo**.
- Follow the on-screen instruction (“**Start**”) to ignore a false echo. (Press the **Enter** (↵) key if prompted to change the mode to “off-line”).
- Select “**Quit**” to exit to the previous menu.

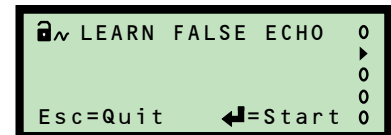

(Mobrey MCU901 Screen)

Note

- See **Clear False Echoes** on page 143 for how to clear all learned false echoes.
- See **False Echo Data** on page 142 for how to edit existing false echo data.
- Use the “**Auto Tank Map**” feature for automatic learning (page 94).

F.2.5 Auto tank map

Fast Keys	2, 2, 6 [or 7], 7
------------------	-------------------

The transmitter can automatically map up to **four** echoes from false targets within an empty tank. The tank needs to be empty so that echoes from all false targets are exposed.

Note

- Set the **Bottom Reference** (page 105) before using Auto Tank Map.

Field Communicator

To automatically map up to **four** echoes from false targets:

- From the *Home* screen, select **2: Configure**.
- Select **2: Manual Setup**.
- Select **6: False Echoes** (*MSP900GH*) or **7: False Echoes** (*MSP400RH*).
- Select **7: Auto Tank Map**.
- Wait while the transmitter learns about the empty tank to ignore the false echoes. This process takes less than one minute.

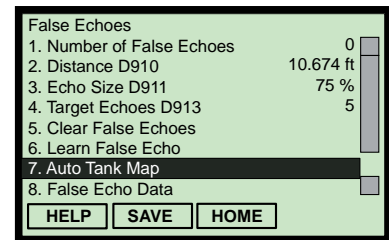

(Field Communicator Screen)

Note

- When messages appear, take appropriate action if needed and press “OK”.

Mobrey MCU900 Series control unit

To automatically map up to **four** echoes from false targets:

- From the *Main Menu* screen, select **SETUP**.
- Select the transmitter (e.g. “Tx1 : MSP400RH”).
- Select **ENGINEERING**, and then **FALSE ECHO ACTION**.
- Select **Auto Tank Map**.
- Follow the on-screen instruction (“**start**”) to ignore a false echo. (Press the **Enter** key if prompted to change the mode to “off-line”).
- Wait while the transmitter learns about the empty tank to ignore the false echoes. The process takes less than one minute.
- Select “**Quit**” to exit to the previous menu.

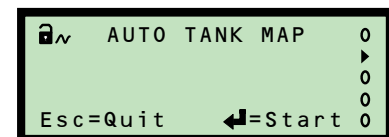

(Mobrey MCU901 Screen)

Note

- See **Clear False Echoes** on page 143 for how to clear all learned false echoes.
- See **False Echo Data** on page 142 for how to edit existing false echo data.
- Use the “**Learn False Echo**” feature manual learning (page 93).

F.2.6 Simulation of PV

Fast Keys	3, 5, 1
-----------	---------

The transmitter simulations automatically cycle the PV between the bottom of the tank and the nearest measurable distance. The cycle direction is given by the name of the simulation mode selected. Simulation modes are:

- “Run up” – cycles up, and then down, repeatedly until stopped.
- “Run down” – cycles down, and then up, repeatedly until stopped.
- “Run from Zero” – as “Run up” except the PV initially starts from 0.

A single cycle takes 100 seconds to complete. The Current Output responds according to the PV.

The cycling may be paused with the “pause” mode, and then re-started by selecting another simulation mode. To stop the cycling, select the “normal” mode.

Field Communicator

To use the simulation tool:

1. From the *Home* screen, select **3: Service Tools**.
2. Select **5: Simulate**.
3. Select **1: Primary Variable**.
4. Select **2: Change Mode**.
5. Select a simulation mode e.g. **2: Run Up**.
6. The simulation is now running, and Simulation Enabled is “ON”.
7. Monitor the parameters **Primary Variable (PV)**, **Current Output**, and **Percentage of Current Output** on the LCD screen.
8. When finished, change the mode to “Normal”.

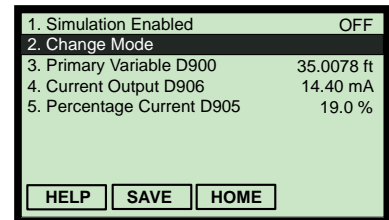

(Field Communicator Screen)

Note

- When messages appear, take appropriate action if needed and press “OK”.

Mobrey MCU900 Series control unit

To use the simulation tool:

1. From the *Main Menu* screen, select **SETUP**.
2. Select the transmitter (e.g. “Tx1:MSP400RH”).
3. Select **SYSTEM**, and then **Simulation**.
4. Select a simulation mode.
5. When finished, select “Quit” to exit to the previous menu.

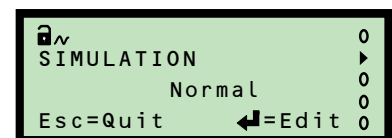

(Mobrey MCU901 Screen)

F.2.7 Restart device

Fast Keys	3, 4, 3, 1
-----------	------------

This re-starts the transmitter as if the power has been interrupted.

Field Communicator

To restore the original factory configuration:

1. From the *Home* screen, select **3: Service Tools**.
2. Select **4: Maintenance**.
3. Select **3: Utilities**, and then **1: Restart Device**.
4. When the message “About to restart the transmitter” appears, press “**OK**” to continue (or “**ABORT**” to not continue).
5. Select **1: Yes** to restart the transmitter.

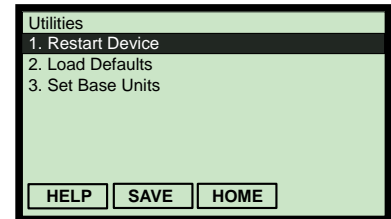

(Field Communicator Screen)

Note

- When messages appear, take appropriate action if needed and press “**OK**”.

Mobrey MCU900 Series control unit

To restore the original factory configuration:

1. From the *Main Menu* screen, select **SETUP**.
2. Select the transmitter (e.g. “**Tx1 : MSP400RH**”).
3. Select **SYSTEM**.
4. Select **RESTART DEVICE**.
5. Follow the on-screen instruction (“**Start**”) to restart the transmitter. (Press the **Enter** (↵) key if prompted to change the mode to “off-line”).
6. Select “**Quit**” to exit to the previous menu.

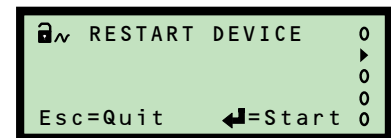

(Mobrey MCU901 Screen)

F.2.8 Load defaults

Fast Keys	3, 4, 3, 2
-----------	------------

This restores the transmitter parameters to the factory default values for the selected base units. This is sometimes necessary, particularly if the data held in the transmitter is in doubt.

Note

- Restoring the factory defaults values overwrites all site entered data. After loading the factory defaults, the transmitter automatically re-starts and communication is interrupted until the re-start is complete.

Field Communicator

To restore the factory default settings of the transmitter:

- From the *Home* screen, select **3: Service Tools**.
- Select **4: Maintenance**.
- Select **3: Utilities**.
- Select **2: Load Defaults**.
- When the message “About to restore factory defaults” appears, press “**OK**” to continue (or “**ABORT**” to not continue).
- Select **1: Yes** to restore the factory defaults.

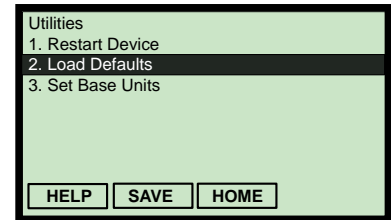

(Field Communicator Screen)

Note

- When messages appear, take appropriate action if needed and press “**OK**”.

Mobrey MCU900 Series control unit

To restore the factory default settings of the transmitter:

- From the *Main Menu* screen, select **SETUP**.
- Select the transmitter (e.g. “**Tx1:MSP400RH**”).
- Select **SYSTEM**, and then select **DEFAULTS**.
- Follow the on-screen instructions (select “**Start**” and answer “**Yes**”) to restore the factory defaults. Press the **Enter** (↵) key if prompted to change the mode to “**off-line**”.
- Select “**Quit**” to exit to the previous menu.

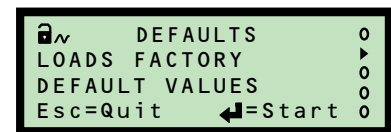

(Mobrey MCU901 Screen)

F.2.9 Simulate current output

Fast Keys	3, 5, 2, 1
-----------	------------

This forces a fixed output current in the range 4 to 20 mA. This feature *temporarily* overrides the normal function of the transmitter's PV driving the 4–20 mA Current Output until exiting to the previous menu.

Note

- The simulation is automatically cancelled after 20 minutes, and the output current returns to representing the transmitter's PV.

Field Communicator

To fix the output current:

1. From the *Home* screen, select **3: Service Tools**.
2. Select **5: Simulate**.
3. Select **2: Loop Current**.
4. Select **1: Loop Test**.
5. Select the required output current e.g. **1: 4mA**.
6. When a message appears saying the output current is fixed, press **“OK”**.
7. Select **4: End** to exit and restore the output current to normal.

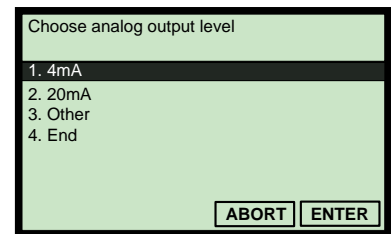

(Field Communicator Screen)

Note

- When messages appear, take appropriate action if needed and press **“OK”**.

Mobrey MCU900 Series Control Unit

To fix the output current:

1. From the *Main Menu* screen, select **SETUP**.
2. Select the transmitter (e.g. **“Tx1: MSP400RH”**).
3. Select **SYSTEM**, and then select **TRIM**.
4. Select **Fix Current**.
5. Follow on-screen instructions to input the required output current.
(Press the **Enter (↵)** key if prompted to change mode to **“off-line”**).
6. When finished, select **“quit”** to exit to the previous menu.

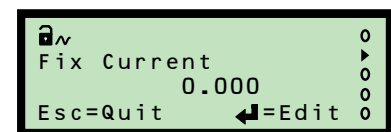

(Mobrey MCU901 Screen)

F.2.10 Trim 4 mA / Trim 20 mA

Fast Keys	3, 4, 1, 1
-----------	------------

This is for calibrating the 4 mA and 20 mA output current from the transmitter. The output current is temporarily set to 4 mA and 20 mA. Measure the *actual output current* and then input that mA value to re-calibrate. The output current resumes normal operation after exiting.

Note

- The re-calibration procedure is automatically cancelled after 20 minutes of inactivity, and the previous calibration is restored.

Field Communicator

To re-calibrate the 4 mA and 20 mA output current:

1. From the *Home* screen, select **3: Service Tools**.
2. Select **4: Maintenance**.
3. Select **1: Analog Calibration**.
4. Select **1: D/A Trim**.
5. Follow the instruction “**Connect reference meter**”, and then press “**OK**”.
6. Input the measured mA from the reference meter, and press “**ENTER**”.
7. Select **1: Yes**, and then “**OK**” to now calibrate the 20 mA output current.
8. Input the measured mA from the reference meter, and press “**ENTER**”.
9. Select **1: Yes**. (The output current now returns to normal operation).

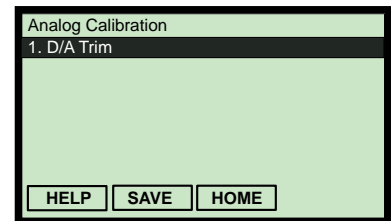

(Field Communicator Screen)

Note

- When messages appear, take appropriate action if needed and press “OK”.

Mobrey MCU900 Series control unit

To re-calibrate the 4 mA output current:

1. From the *Main Menu* screen, select **SETUP**.
2. Select the transmitter (e.g. “**Tx1:MSP400RH**”).
3. Select **SYSTEM, TRIM**, and then **Trim 4mA**.
4. Connect a reference meter.
5. Follow the on-screen instructions to start the re-calibration feature. (Press the **Enter** (↵) key if prompted to change the mode to “off-line”).
6. Input the measured mA from the reference meter, and select “**Save**”.

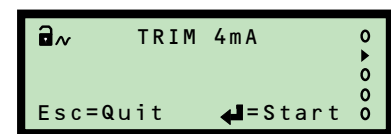

(Mobrey MCU901 Screen)

7. Select the “**Quit**” instruction to exit.

To re-calibrate the 20 mA output current:

1. From the *Main Menu* screen, select **SETUP**.
2. Select the transmitter (e.g. “**Tx1:MSP400RH**”).
3. Select **SYSTEM**
4. Select **TRIM**
5. Select **Trim 20mA**.
6. Follow the on-screen instructions to start the re-calibration feature.
(Press the **Enter** (↵) key if prompted to change mode to “**off-line**”).
7. Measure the *actual output current*, and input that new value.
8. Select “**Quit**” to exit to the previous menu.

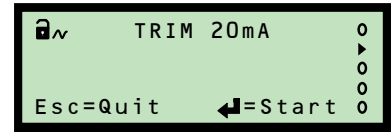

(Mobrey MCU901 Screen)

F.3 Configuration parameters

F.3.1 Message (P000)

Fast Keys	2, 2, 4 [or 5], 1, 3
-----------	----------------------

This allows a general 32-character message to be edited (12 characters if using a MCU900 Series Control Unit). It can be used for any purpose, such as a support contact number, or details of last programming change.

Field Communicator

To view or change the message:

1. From the *Home* screen, select **2: Configure**.
2. Select **2: Manual Setup**.
3. Select **4: HART / Identity** (*MSP900GH*) or **5: HART / Identity** (*MSP400RH*).
4. Select **1: Identity**, and then **3: Message P000**.
5. If a change is required:
 - (a) Input the new message, and then press “**ENTER**” to save it.
 - (b) Press “**SEND**” to update the transmitter.

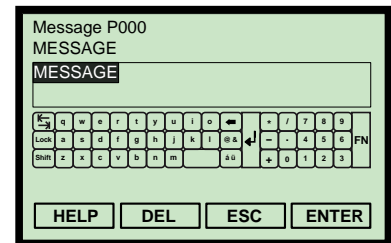

(Field Communicator Screen)

Mobrey MCU900 Series control unit

To view or change the message:

1. From the *Main Menu* screen, select **SETUP**.
2. Select the transmitter (e.g. “**Tx1: MSP400RH**”).
3. Select **DUTY, IDENTITY**, and then **Message**.
4. Follow on-screen instructions to input and save the message.
5. Select “**Quit**” to exit to the previous menu.

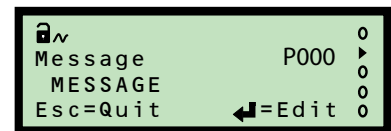

(Mobrey MCU901 Screen)

F.3.2 Tag (P001)

Fast Keys	2, 2, 4 [or 5], 1, 1
------------------	----------------------

This is for editing an electronic ‘label’ of up to 8 characters for the transmitter. The tag is typically a reference number, location, or duty description.

Field Communicator

To view or change the tag:

1. From the *Home* screen, select **2: Configure**.
2. Select **2: Manual Setup**.
3. Select **4: HART / Identity (MSP900GH)** or **5: HART / Identity (MSP400RH)**.
4. Select **1: Identity**, and then **1: Tag P001**.
5. If required:
 - (a) Input the new tag, and then press “**ENTER**” to save it.
 - (b) Press “**SEND**” to update the transmitter.

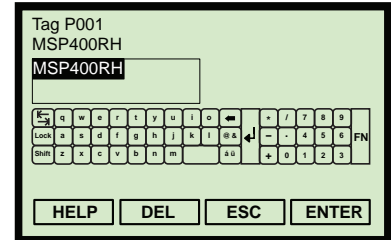

(Field Communicator Screen)

Mobrey MCU900 Series control unit

To view or change the tag:

1. From the *Main Menu* screen, select **SETUP**.
2. Select the transmitter (e.g. “**Tx1: MSP400RH**”).
3. Select **DUTY, IDENTITY**, and then **Tag**.
4. Follow on-screen instructions to input and save the tag.
5. Select “**Quit**” to exit to the previous menu.

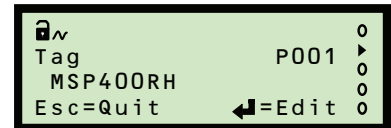

(Mobrey MCU901 Screen)

F.3.3 Descriptor (P002)

Fast Keys	2, 2, 4 [or 5], 1, 2
------------------	----------------------

This is for editing up to 16 characters, and can be used for any purpose e.g. to expand on **Tag** (page 102) if needed.

Field Communicator

To view or change the descriptor:

1. From the *Home* screen, select **2: Configure**.
2. Select **2: Manual Setup**.
3. Select **4: HART / Identity (MSP900GH)** or **5: HART / Identity (MSP400RH)**.

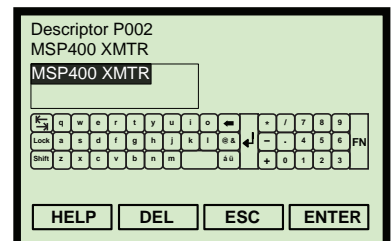

(Field Communicator Screen)

4. Select **1: Identity**, and then **2: Descriptor P002**.
5. If required:
 - (a) Input the descriptor, and then press “**ENTER**” to save it.
 - (b) Press “**SEND**” to update the transmitter.

Mobrey MCU900 Series control unit

To view or change the descriptor:

1. From the *Main Menu* screen, select **SETUP**.
2. Select the transmitter (e.g. “**Tx1: MSP400RH**”).
3. Select **DUTY, IDENTITY**, and then **Descriptor**.
4. Follow on-screen instructions to input and save the descriptor.
5. Select “**Quit**” to exit to the previous menu.



(Mobrey MCU901 Screen)

F.3.4 Final assembly number (P004)

Fast Keys	2, 2, 4 [or 5], 1, 8
-----------	----------------------

This is a factory-set parameter showing a multiple-digit number. It is used by the factory to track the manufacturing history of an individual transmitter.

Field Communicator

To view the final assembly number:

1. From the *Home* screen, select **2: Configure**.
2. Select **2: Manual Setup**.
3. Select **4: HART / Identity (MSP900GH)** or **5: HART / Identity (MSP400RH)**.
4. Select **1: Identity**, and then **8: Final Assembly Number P004**.
5. Press “**EXIT**” to exit to the previous menu.

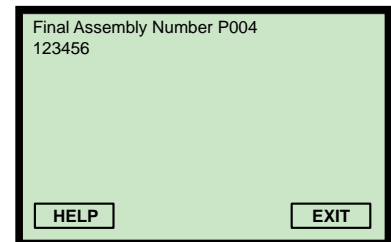

(Field Communicator Screen)

Mobrey MCU900 Series control unit

To view the final assembly number:

1. From the *Main Menu* screen, select **SETUP**.
2. Select the transmitter (e.g. “**Tx1: MSP400RH**”).
3. Select **SYSTEM, FIXED**, and then **Final Assy No.**
4. When finished, press the **ESC** key to exit to the previous menu.

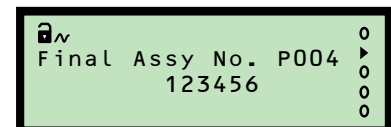

(Mobrey MCU901 Screen)

F.3.5 Serial number (P005)

Fast Keys	2, 2, 4 [or 5], 1, 9
-----------	----------------------

This is a factory-set parameter showing a multiple-digit number. It is used by the factory to identify an individual transmitter.

Field Communicator

To view the serial number:

1. From the *Home* screen, select **2: Configure**.
2. Select **2: Manual Setup**.
3. Select **4: HART / Identity (MSP900GH)** or **5: HART / Identity (MSP400RH)**.
4. Select **1: Identity**, and then **9: Serial Number P005**.
5. Press “**EXIT**” to exit to the previous menu.

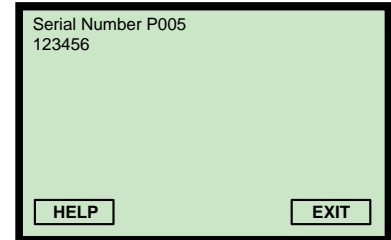

(Field Communicator Screen)

Mobrey MCU900 Series control unit

To view the serial number:

1. From the *Main Menu* screen, select **SETUP**.
2. Select the transmitter (e.g. “**Tx1 :MSP400RH**”).
3. Select **SYSTEM, FIXED**, and then **Serial Number**.
4. When finished, press the **ESC** key to exit to the previous menu.

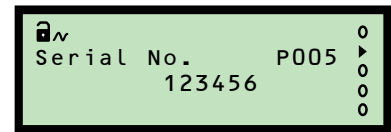

(Mobrey MCU901 Screen)

F.3.6 Bottom reference (P010)

Fast Keys	2, 2, 1, 2
-----------	------------

This is the transmitter’s **Bottom Reference** setting. It is the distance measured vertically along the ultrasonic beam path from the *user preferred sensor reference point* to the *zero level* of a tank or an open channel (see [Figure F-1 on page 106](#)). It is not necessary to have the 4 mA output start at the zero level, and the 4 mA starting pointing can be any liquid height above or below this zero level.

Note

- This parameter is important for calibrating and configuring the transmitter.

Field Communicator

To view or change the bottom reference:

- From the *Home* screen, select **2: Configure**.
- Select **2: Manual Setup**.
- Select **1: Basic Setup**.
- Select **2: Bottom Reference P010**.
- If a change is required:
 - Input the new bottom reference, and then press “**ENTER**” to save it.
 - Press “**SEND**” to update the transmitter.

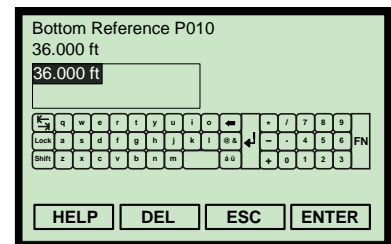

(Field Communicator Screen)

Mobrey MCU900 Series control unit

To view or change the bottom reference:

- From the *Main Menu* screen, select **SETUP**.
- Select the transmitter (e.g. “**Tx1:MSP400RH**”).
- Select **DUTY**.
- Select **Bottom Ref.**
- Follow the on-screen instructions to input and save the new setting. (Press the **Enter** (↵) key if prompted to change mode to “**off-line**”).
- Select “**Quit**” to exit to the previous menu.

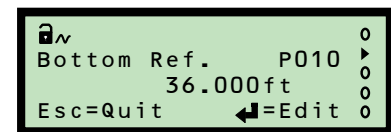

(Mobrey MCU901 Screen)

Figure F-1. Tank geometry

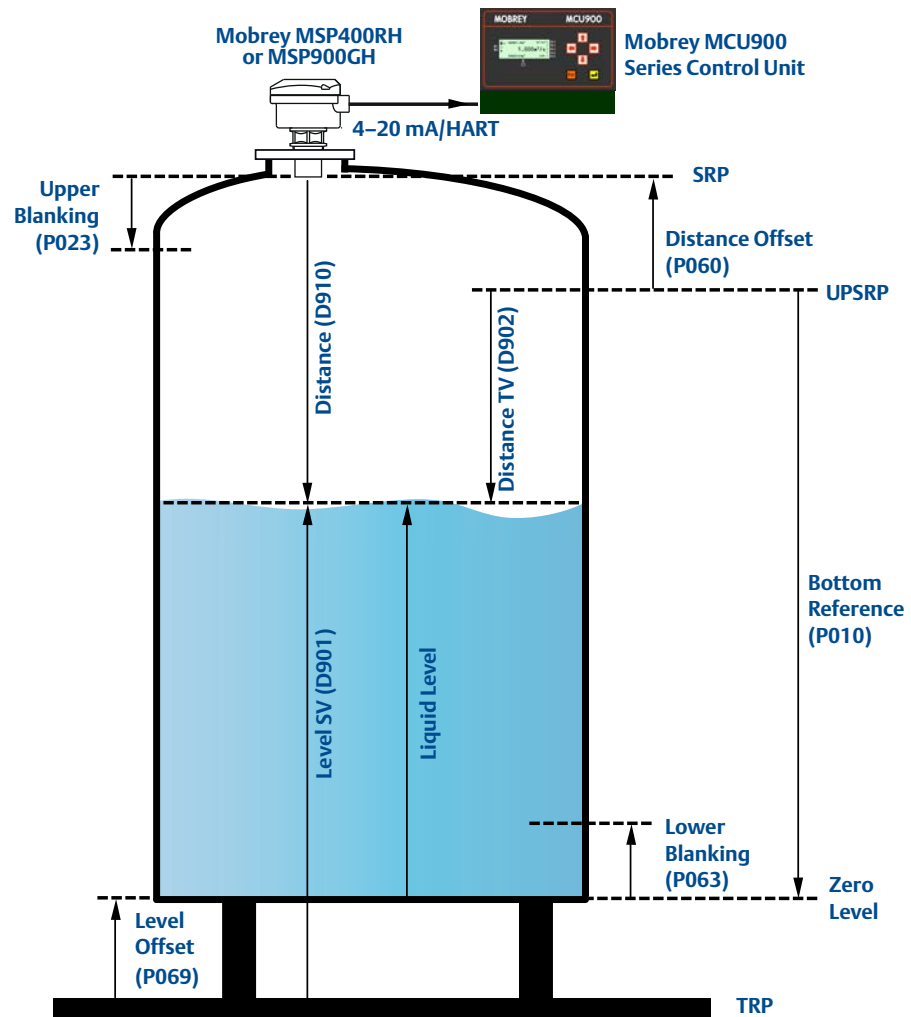

Abbreviations:
TRP= Tank Reference Point
SRP = Sensor Reference Point
UPSRP = User Preferred SRP

Data processing sequence:

1. Echoes are processed that occur between **Upper Blanking (P023)** and **Lower Blanking (P063)**.
2. D910 is derived from the Target Echo's Time of Flight and the calculated Speed of Sound: $D910 = (\text{Time of Flight} \times \text{Speed of Sound}) / 2$
3. $D902 = (D910 - P060)$
4. $\text{Liquid Level} = (P010 - D902)$
5. $D901 = (\text{Liquid Level} + P069)$

F.3.7 Upper blanking (P023)

Fast Keys	2, 2, 5 [or 6], 5
------------------	-------------------

This defines a zone close to the transmitter where echoes are to be ignored. Establishing this zone eliminates echoes from false targets such as mounting fittings or the end of stub pipes.

Enter the vertical distance from the transmitter face to where a valid surface echo can be detected. See [Figure F-1 on page 106](#) for this zone in a tank geometry illustration.

Note

- To avoid a false high level alarm, the upper blanking distance should not be set to less than the factory default setting.
- The pulse transmission stops if the sum of the **Lower Blanking** ([page 110](#)) and **Upper Blanking** and is greater than the **Bottom Reference** ([page 105](#)).

Field Communicator

To view or change the upper blanking distance:

1. From the *Home* screen, select **2: Configure**.
2. Select **2: Manual Setup**.
3. Select **5: Engineering (MSP900GH)** or **6: Engineering (MSP400RH)**.
4. Select **5: Upper Blanking P023**.
5. If a change is required:
 - (a) Input the new blanking distance, and press “**ENTER**” to save it.
 - (b) Press “**SEND**” to update the transmitter.

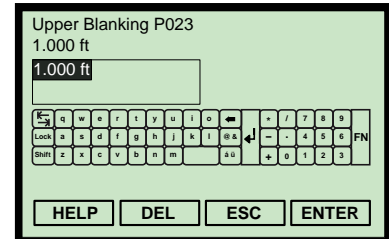

(Field Communicator Screen)

Note

- When messages appear, take appropriate action if needed and press “**OK**”.

Mobrey MCU900 Series control unit

To view or change the upper blanking distance:

1. From the *Main Menu* screen, select **SETUP**.
2. Select the transmitter (e.g. “**Tx1:MSP400RH**”).
3. Select **ENGINEERING**.
4. Select **Upper Blanking**.
5. Follow the on-screen instructions to edit and save the new setting. (Press the **Enter** (↵) key if prompted to change mode to “**off-line**”).
6. Select “**Quit**” to exit to the previous menu.

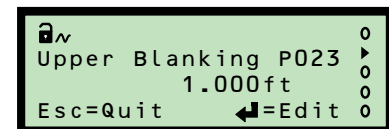

(Mobrey MCU901 Screen)

F.3.8 Lower blanking (P063)

Fast Keys	2, 2, 5 [or 6], 6
-----------	-------------------

This defines a zone above the **Bottom Reference** (page 105) where echoes are to be ignored. This zone eliminates echoes from false targets at the tank bottom e.g. pumps uncovered as the liquid level decreases.

Note

- See Figure F-1 on page 106 for this zone in a tank geometry illustration.
- The pulses transmission stops if the sum of the **Upper Blanking** (page 131) and **Lower Blanking** is greater than the **Bottom Reference** (page 105).

Field Communicator

To view or change the lower blanking distance:

- From the *Home* screen, select **2: Configure**.
- Select **2: Manual Setup**.
- Select **5: Engineering (MSP900GH)** or **6: Engineering (MSP400RH)**.
- Select **6: Lower Blanking**.
- If a change is required:
 - Input the new blanking distance, and press “**ENTER**” to save it.
 - Press “**SEND**” to update the transmitter.

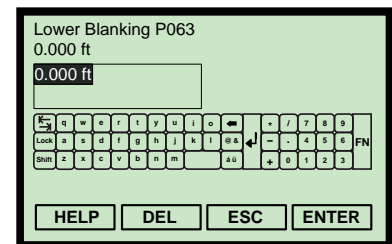

(Field Communicator Screen)

Note

- When messages appear, take appropriate action if needed and press “**OK**”.

Mobrey MCU900 Series control unit

To view or change the lower blanking distance:

- From the *Main Menu* screen, select **SETUP**.
- Select the transmitter (e.g. “**Tx1: MSP400RH**”).
- Select **ENGINEERING**.
- Select **Lower Blanking**.
- Follow the on-screen instructions to edit and save the new setting. (Press the **Enter** (↵) key if prompted to change mode to “**off-line**”).
- Select “**Quit**” to exit to the previous menu.

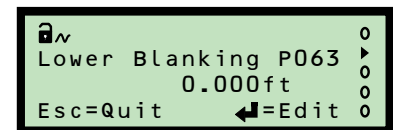

(Mobrey MCU901 Screen)

F.3.9 Distance offset (P060)

Fast Keys	2, 2, 2, 2
-----------	------------

This defines the distance from the Sensor Reference Point (SRP) to the User Preferred Sensor Reference Point (UPSRP).

Note

- See Figure F-1 on page 106 for these points in a tank geometry illustration.

The read-only **Distance / Tertiary Variable** value (page 149) is calculated by subtracting the distance offset from the live **Distance** value (page 153).

Note

- The live **Distance** value is not affected by changes to the distance offset.

Field Communicator

To view or change the distance offset:

- From the *Home* screen, select **2: Configure**.
- Select **2: Manual Setup**.
- Select **2: Level**.
- Select **2: Distance Offset P060**.
- If a change is required:
 - Input the new distance offset, and press “**ENTER**” to save it.
 - Press “**SEND**” to update the transmitter.

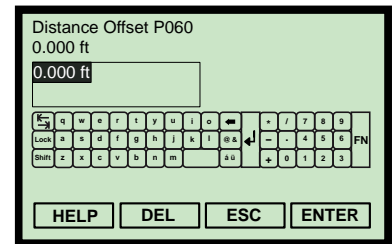

(Field Communicator Screen)

Note

- When messages appear, take appropriate action if needed and press “**OK**”.

Mobrey MCU900 Series control unit

To view or change the distance offset:

- From the *Main Menu* screen, select **SETUP**.
- Select the transmitter (e.g. “**Tx1 : MSP400RH**”).
- Select **DUTY**.
- Select **Distance Offset**.
- Follow the on-screen instructions to edit and save the new setting. (Press the **Enter** (↵) key if prompted to change mode to “**off-line**”).
- Select “**Quit**” to exit to the previous menu.

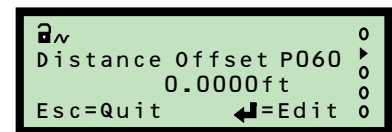

(Mobrey MCU901 Screen)

F.3.10 Level offset (P069)

Fast Keys	2, 2, 2, 4
-----------	------------

This defines the distance from the Tank Reference Point (TRP) to the transmitter's Bottom Reference.

Note

- See Figure F-1 on page 106 for these points in a tank geometry illustration.

The read-only **Level / Secondary Variable value** (page 148) is calculated by adding the level offset and the measured level.

Field Communicator

To view or change the level offset:

- From the *Home* screen, select **2: Configure**.
- Select **2: Manual Setup**.
- Select **2: Level**.
- Select **4: Level Offset P069**.
- If a change is required:
 - Input the new level offset, and press **"ENTER"** to save it.
 - Press **"SEND"** to update the transmitter.



(Field Communicator Screen)

Note

- When messages appear, take appropriate action if needed and press **"OK"**.

Mobrey MCU900 Series control unit

To view or change the level offset:

- From the *Main Menu* screen, select **SETUP**.
- Select the transmitter (e.g. **"Tx1: MSP400RH"**).
- Select **DUTY**.
- Select **Level Offset**.
- Follow the on-screen instructions to edit and save the new setting.
(Press the **Enter** (↵) key if prompted to change the mode to "off-line").
- Select **"Quit"** to exit to the previous menu.

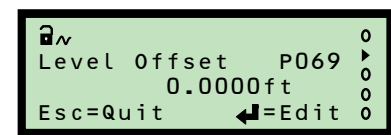

(Mobrey MCU901 Screen)

F.3.11 Tank shape / non-linear profile (P011)

Fast Keys	2, 2, 3, 2
-----------	------------

This selects the shape of a tank or an open channel, and establishes the linear or non-linear relationship between the live liquid level (height) and the process value (PV) derived from that level.

Note

- The display (reported) measurement units for the output process value (PV) are set using the **Primary Variable Units** parameter (page 120). However, this does not automatically re-scale the PV. Use parameter **PV Scale Factor** (page 121) to manually re-scale the value.

The transmitter is pre-programmed with popular profiles that are mathematical formulas to convert a linear level reading to a flow or volumetric process value (PV). The Current Output is then driven by the flow or volumetric PV. The profile options are described in the following sections:

- “Contents (volume) measurement” on page 112 and “Flow measurement” on page 116

Field Communicator

To change the tank shape / non linear profile:

- From the *Home* screen, select **2: Configure**.
- Select **2: Manual Setup**, and then **3: Profiling**.
- Select **2: Set Non-Linear Profile**.
- Select a new profile, and then press “**ENTER**” to save the selection.
- Press “**SEND**” to update the transmitter.

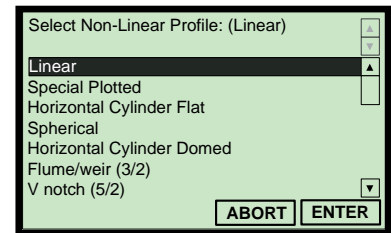

(Field Communicator Screen)

Note

- When messages appear, take appropriate action if needed and press “**OK**”.
- The selected profile can be viewed at Fast Key sequence 2, 2, 3, 3.

Mobrey MCU900 Series control unit

To view or change the tank shape:

- From the *Main Menu* screen, select **SETUP**.
- Select the transmitter (e.g. “**Tx1:MSP400RH**”).
- Select **DUTY**, and then select **Tank Shape**.
- Follow the on-screen instructions to select and save the new setting. (Press the **Enter** (↵) key if prompted to change mode to “**off-line**”).
- Select “**Quit**” to exit to the previous menu.

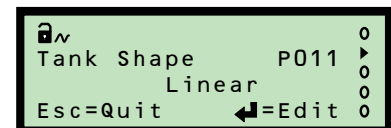

(Mobrey MCU901 Screen)

F.3.12 Contents (volume) measurement

There are five shape options available to select, including:

- Tank Shape/NLP (P011) = “Linear” (see page 112)
- Tank Shape/NLP (P011) = “Special Plot” (see page 112)
- Tank Shape/NLP (P011) = “Horizontal Cyl Flat” (see page 115)
- Tank Shape/NLP (P011) = “Spherical” (see page 115)
- Tank Shape/NLP (P011) = “Horizontal Cyl Dome” (see page 115)

Tank Shape/NLP (P011) = “Linear”

This default setting is for level or volume (content) measurements involving a tank with a constant cross-section. When “Linear” is selected, the level or volume is the liquid height above the *zero level* multiplied by a scaling factor. If volume is not required, the **Scale Factor** parameter (page 121) is set to 1.0 unless requiring other measurement units for the output PV.

The volume of the contents is calculated by entering the volume-per-meter of height into the **Scale Factor** parameter (page 121). If the liquid level is being measured in feet or inches, enter the volume-per-foot or volume-per-inch respectively.

Tank Shape/NLP (P011) = “Special Plot”

When selecting “Special Plot”, parameters **Profile Point 1 to 10** (page 124) can be edited to plot the unique profile of an irregular shaped tank or open channel (see Figure F-2).

Figure F-2. Two-stage weir cross-section

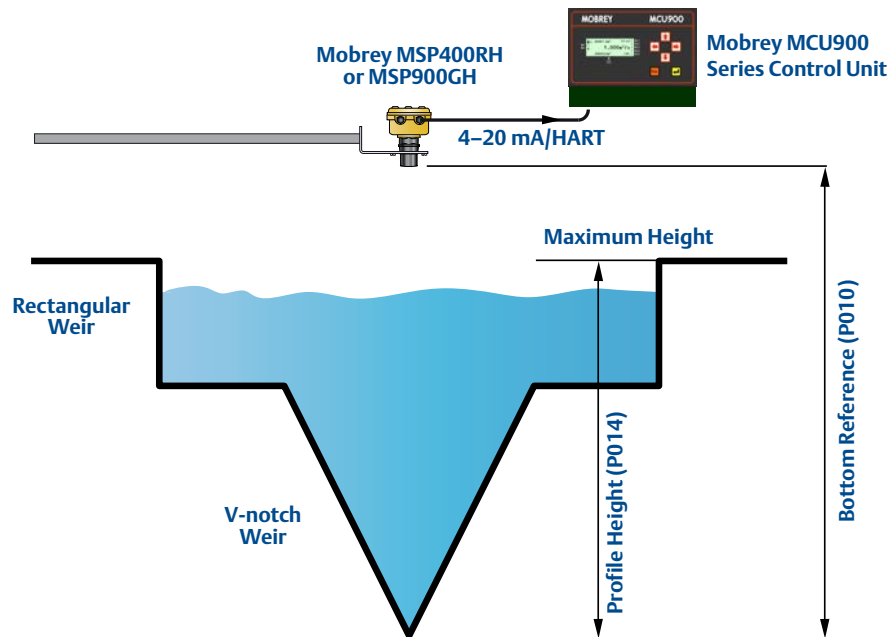

To derive the 10 profile points, it is necessary to have tabulated or graphical data to relate the process value (PV) to the live liquid height. Figure F-3 on page 114 shows an example graph of PV versus Liquid Height. In the example, 60% of the maximum height on the X-axis relates to a

percentage of the maximum PV on the Y-axis. The related percentage, say 55%, is entered into parameter **Profile Point 6**.

The transmitter will interpolate linearly between the plotted points to give an accurate curve fit, which will determine the output PV from the live level (height) measurement.

Each live level measurement is converted into a percentage (0 to 100%), which is proportional to the maximum height. In graph terms, the converted percentage corresponds to an X ordinate on the X-axis. Using this X ordinate, the Y ordinate is then calculated to get a percentage proportional to the maximum PV. This percentage is multiplied by the maximum height to get the output process value (PV).

Setting-up procedure for “**Special Plot**” option:

1. Select the displayed (reported) units for the output PV (see [page 120](#)).
2. Draw the graph of PV versus Liquid Height, and note the maximum points.
3. Enter the *maximum* liquid height into **Profile Height** ([page 122](#)).
4. Enter the *maximum* volume or flow into **PV Scale Factor** ([page 121](#)).
5. Enter the distance from the transmitter face to the zero point (Y=0) into the **Bottom Reference** parameter ([page 105](#)).
6. Use parameters **Profile Point 1 (P030)** to **Profile Point 10 (P039)** to enter the percentage values that relate to the X-axis fixed percentages.

Note

- The origin (0,0) is always used as the start point. It is not a parameter.
 - It is possible the process value (PV) at the maximum height is less than 100% of the maximum volume or flow. (See [Figure F-4 on page 114](#)).
-

Figure F-3. Graph 1 of PV versus Height

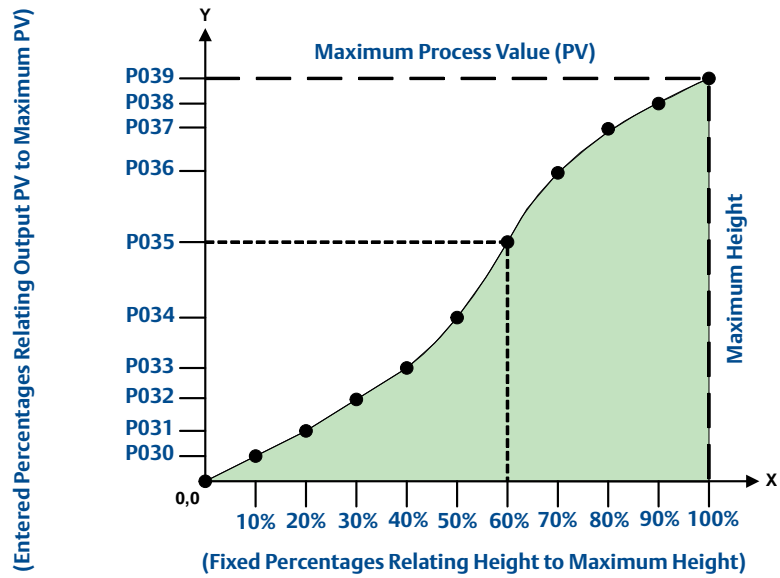
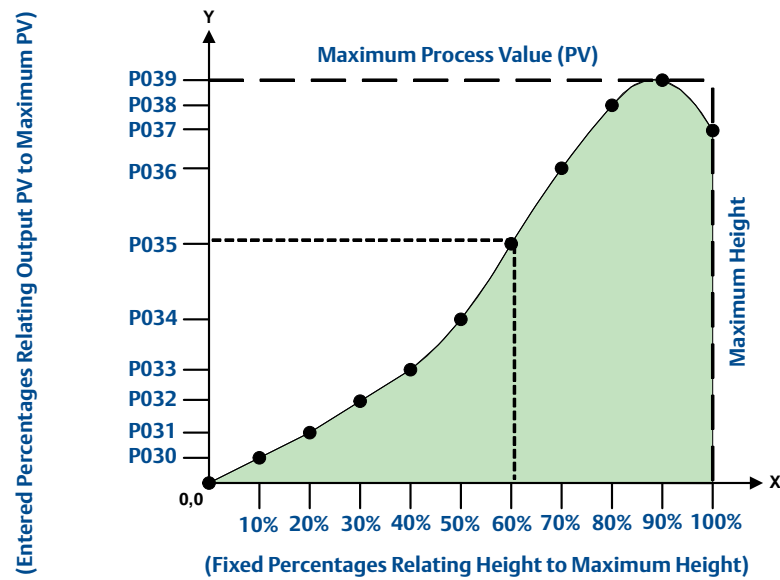

Figure F-4. Graph 2 of PV versus Height



Tank Shape/NLP (P011) = “Horizontal Cyl Flat”

This Horizontal Cylinder With Flat Ends setting is applicable when volume measurements are needed from a horizontally-oriented cylindrical tank with a constant diameter (see [Figure F-5 on page 116](#) for a cross-sectional view).

The volume is calculated from the live level measurement, the full volume of an ideal cylindrical tank, and the diameter of that tank.

Setting-up Procedure for “Horizontal Cyl Flat”:

1. Use the **Tank Shape/NLP (P011)** parameter to select “Horizontal Cyl Flat”.
2. Enter the full volume into the **PV Scale Factor** parameter ([page 121](#)).
3. Enter the tank diameter into the **Profile Height / Power Factor** parameter ([page 122](#)).

Tank Shape/NLP (P011) = “Spherical”

This setting is applicable when volume measurements are needed from a spherical tank with a constant diameter (see [Figure F-5 on page 116](#) for a cross-sectional view).

The volume is calculated from the liquid level measurement and the full volume of the ideal spherical tank.

Setting-up Procedure for “Spherical”:

1. Use the **Tank Shape/NLP (P011)** parameter to select “Spherical”.
2. Enter the full volume into the **PV Scale Factor** parameter ([page 121](#)).
3. Enter the tank diameter into the **Profile Height / Power Factor** parameter ([page 122](#)).

Tank Shape/NLP (P011) = “Horizontal Cyl Dome”

This Horizontal Cylinder With Domed Ends setting is applicable when volume measurements are needed from a horizontally-oriented cylindrical tank with a constant diameter (see [Figure F-5 on page 116](#) for a cross-sectional view).

The volume is calculated from the live level measurement, the full volume of an ideal cylindrical tank, and the diameter of that tank.

Setting-up Procedure for “Horizontal Cyl Dome”:

1. Use the **Tank Shape/NLP (P011)** parameter to select “Horizontal Cyl Dome”.
2. Enter the full volume into the **PV Scale Factor** parameter ([page 121](#)).
3. Enter the tank diameter into the **Profile Height / Power Factor** parameter ([page 122](#)).

Figure F-5. Cylindrical or spherical tank cross-section

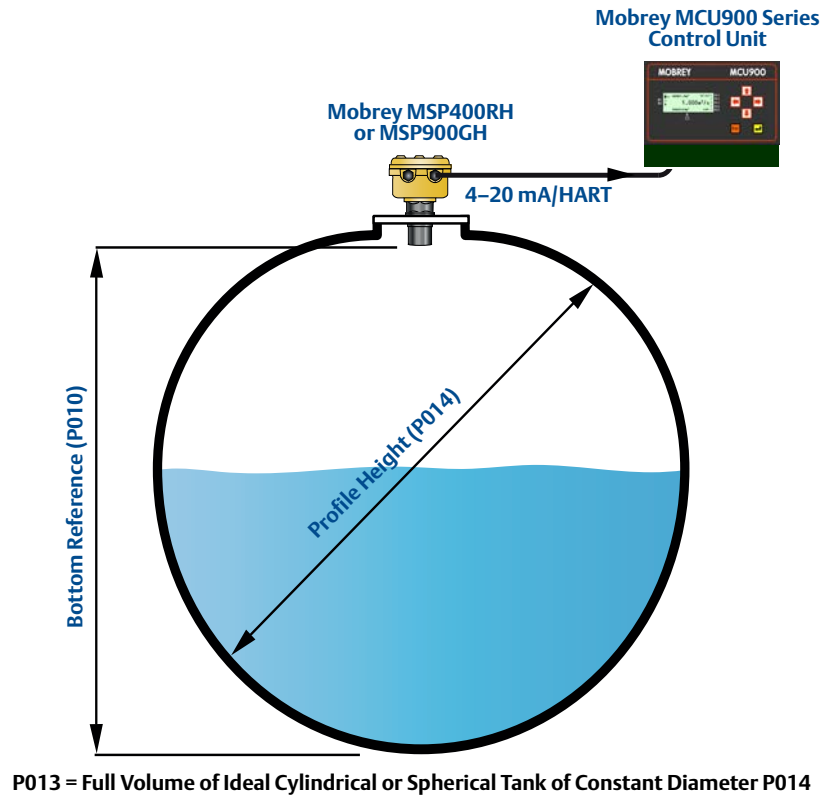

F.3.13 Flow measurement

Table F-1 on page 119 lists the **Tank Shape/Non-Linear Profile (P011)** options that select a standard flow structure profile and the conversion (scale) factors used to calculate a flow process value (PV).

Tank Shape/NLP (P011) = "Special Plot"

The **"Special Plot"** option is used for *irregular-shaped* flow profiles. See page 112 for a full description.

Tank Shape/NLP (P011) = "Flume/Weir-3/2"

This setting is applicable when flow rate measurements are needed from an open channel with a flume or weir profile (see Figure F-6 on page 117).

The rate of flow per second is calculated by:

$$Q = k \times h^{Pwr}$$

Where 'h' is the live liquid level, 'Q' is flow rate per second, 'Pwr' is the power factor and 'k' is a user-entered scale factor.

The transmitter automatically populates parameter **Power Factor / Profile Height** (page 122) with a power factor from Table F-1 on page 119.

Flumes that deviate from the standard “3/2 power law”, e.g. round-bottomed flumes, must use the “**Special Plot**” profile option that is based on flow versus height tabulations (see page 112).

Setting-up procedure for “**Flume/Weir-3/2**”:

1. Use parameter **Tank Shape/NLP (P011)** to select “**Flume/Weir-3/2**”.
2. Enter the scale factor into the **PV Scale Factor** parameter (page 121).

Figure F-6. Rectangular weir cross-section

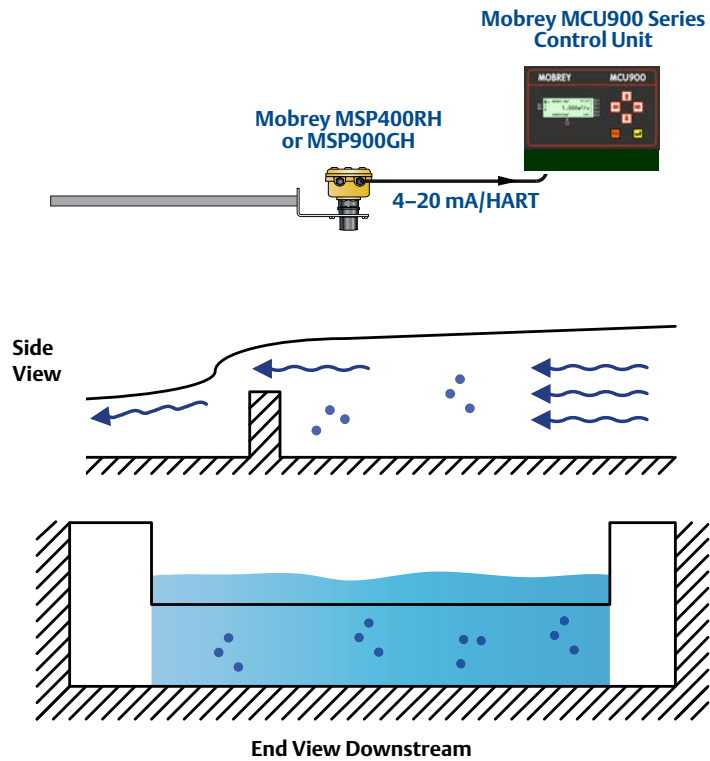

Tank Shape/NLP (P011) = “v-Notch-5/2”

This setting is applicable when flow measurements are needed from an open channel with a V-notch profile.

The rate of flow through a V-notch is calculated using:

$$Q = k \times h^{Pwr}$$

Where ‘h’ is the live liquid level, ‘Q’ is flow rate per second, ‘Pwr’ is the power factor, and ‘k’ is a user-entered scale factor.

The transmitter automatically populates parameter **Power Factor / Profile Height** (page 122) with a power factor from Table F-1 on page 119.

Setting-up Procedure for “V-Notch-5/2”:

1. Edit parameter **Tank Shape/NLP (P011)** to select “V-Notch-5/2”.
2. Enter the scale factor into the **PV Scale Factor** parameter (page 121).

Figure F-7. V-notch cross-section

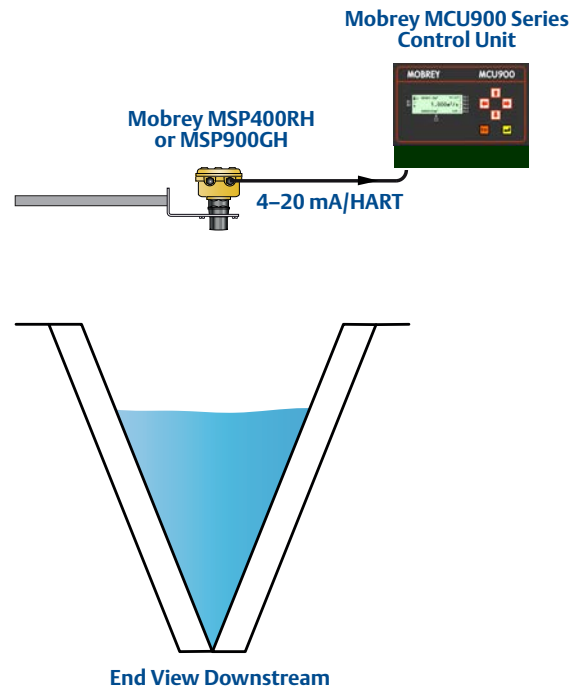

Table F-1. Standard flow profile options

Options	Flow Structures	Hmax		Scale Factor		Power Factor	20 mA Point ⁽¹⁾	
		Metric (m)	Imperial (ft/in.)	Metric (m ³ /hr) ⁽²⁾	Imperial (GPM) ⁽²⁾		Metric (m)	Imperial (ft/in.)
3/2	Flume 3/2 flow law	-		(User) ⁽³⁾	(User) ⁽³⁾	1.5	(User) ⁽³⁾	(User) ⁽³⁾
5/2	V-Notch 5/2 flow law	-		(User) ⁽³⁾	(User) ⁽³⁾	2.5	(User) ⁽³⁾	(User) ⁽³⁾
mann	Manning formula	-		(User) ⁽³⁾	(User) ⁽³⁾	(User) ⁽³⁾	-	-
PAr01	1 inch Parshall flume	0.75	2.5	217.3	151.7	1.55	17.9	87.3
PAr02	2 inch Parshall flume	0.75	2.5	434.6	303.4	1.55	50.7	215
PAr03	3 inch Parshall flume	0.75	2.5	635.5	445.2	1.547	125	516
PAr06	6 inch Parshall flume	0.75	2.5	1372	924.5	1.58	389	1750
PAr09	9 inch Parshall flume	0.75	2.5	1927	1378	1.53	882	3980
PAr1	1 ft. Parshall flume	0.75	2.5	2487	1795	1.522	1610	7240
PAr1.5	1 1/2 ft. Parshall flume	0.75	2.5	3803	2693	1.538	2440	11000
PAr2	2 ft. Parshall flume	0.75	2.5	5143	3590	1.550	3290	14900
PAr3	3 ft. Parshall flume	0.75	2.5	7863	5386	1.566	5010	22600
PAr4	4 ft. Parshall flume	0.75	2.5	10630	7181	1.578	6750	30500
PAr5	5 ft. Parshall flume	0.75	2.5	13440	8976	1.587	8510	38400
PAr6	6 ft. Parshall flume	0.75	2.5	16280	10770	1.595	10300	46400
PAr8	8 ft. Parshall flume	0.75	2.5	22010	14360	1.607	13900	62600
PAr10	10 ft. Parshall flume	0.75	2.5	26862	17672	1.6	20700	89200
FF01 ⁽⁴⁾	Flume Flat 1 (m)	0.102		134.79		1.5	9	
FF02 ⁽⁴⁾	Flume Flat 2 (m)	0.191		178.27		1.5	36	
FF03 ⁽⁴⁾	Flume Flat 3 (m)	0.267		313.42		1.5	90	
FF04 ⁽⁴⁾	Flume Flat 4 (m)	0.406		541.72		1.5	360	
FF05 ⁽⁴⁾	Flume Flat 5 (m)	0.635		811.11		1.5	900	
FF06 ⁽⁴⁾	Flume Flat I	0.200		132.2		1.5	30	
FF07 ⁽⁴⁾	Flume Flat II	0.250		177.7		1.5	60	
FF08 ⁽⁴⁾	Flume Flat III	0.300		217.58		1.5	90	
FF09 ⁽⁴⁾	Flume Flat III bis	0.3333		328.35		1.5	200	
FF10 ⁽⁴⁾	Flume Flat III ter	0.400		272.0		1.5	200	
FF11 ⁽⁴⁾	Flume Flat IV	0.400		352.17		1.5	180	
FF12 ⁽⁴⁾	Flume Flat V	0.500		442.93		1.5	360	
FF13 ⁽⁴⁾	Flume Flat V bis	0.400		400.5		1.5	320	
FF14 ⁽⁴⁾	Flume Flat VI	0.540		499.06		1.5	720	
FF15 ⁽⁴⁾	Flume Flat VII	0.700		623.7		1.5	1080	
FF16 ⁽⁴⁾	Flume Flat VIII	0.600		881.16		1.5	1440	
FF17 ⁽⁴⁾	Flume Flat VIII bis	0.666		798.0		1.5	1500	
FF18 ⁽⁴⁾	Flume Flat IX	0.800		1065.2		1.5	1800	
FF19 ⁽⁴⁾	Flume Flat IX bis	0.733		814.8		1.5	1700	
FF20 ⁽⁴⁾	Flume Flat X	0.867		1322.3		1.5	3600	
FF21 ⁽⁴⁾	Flume Flat X bis	1.200		1609.0		1.5	7500	
FF22 ⁽⁴⁾	Flume Flat X ter	0.959		1064.9		1.5	3500	
FF2 3 ⁽⁴⁾	Flume Flat XI	1.200		1651.0		1.5	7200	
FP01 ⁽⁴⁾	Flume Parabolic 1	0.200		15879		2.3	20	
FP02 ⁽⁴⁾	Flume Parabolic 2	0.250		17591		2.3	40	
FP03 ⁽⁴⁾	Flume Parabolic 3	0.310		11646		2.2	90	
FP04 ⁽⁴⁾	Flume Parabolic 4	0.380		13670		2.2	180	
FP05 ⁽⁴⁾	Flume Parabolic 5	0.460		9802.7		2.1	360	
FP06 ⁽⁴⁾	Flume Parabolic 6	0.600		11368		2.1	720	
FP07 ⁽⁴⁾	Flume Parabolic 7	0.800		12228		2.1	1400	

- (1) Where entries do not say "(User)", the 20 mA Point (Upper Range Value) is automatically set to the value in the meters (m) or feet/inches (ft./in.) column depending on the selected Base Units. The 4 mA Point (Lower Range Value) is automatically set to 0.
- (2) If the Base Units are meters (m), the flow units are m³/hour. Otherwise, flow units are gal/m (GPM). The gallons are US gallons.
- (3) Where shown, "(User)" indicates that the user is required to input the appropriate data.
- (4) FF and FP flume options require the Base Units to be meters (m). See "Changing the base units" on page 60 if a change of Base Units is required.

F.3.14 Primary variable units (P012)

Fast Keys	2, 2, 3, 1
-----------	------------

This selects alternative display units for the HART Primary Variable (PV), which are then reported to a HART Master Device such as a Mobrey MCU900 Series control unit.

Note

- Selecting alternative display units does not automatically re-scale the PV value. Use the parameter **PV Scale Factor** to manually re-scale the value.

Field Communicator

To view or change the displayed units for the PV:

1. From the *Home* screen, select **2: Configure**.
2. Select **2: Manual Setup**.
3. Select **3: Profiling**.
4. Select **1: Primary Variable Units P012**.
5. If a change is required:
 - (a) Select new units, and then press “**ENTER**” to save the selection.
 - (b) Press “**SEND**” to update the transmitter.

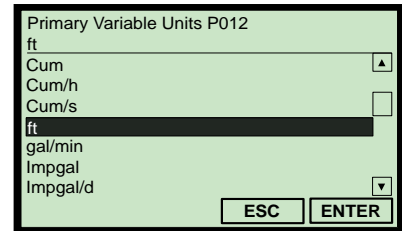

(Field Communicator Screen)

Note

- If the HART PV has no units, select and confirm the “**None**”, “**Unknown**”, or “**Not Used**” option as appropriate for the HART Master Device (host).

Mobrey MCU900 Series control unit

To view or change the displayed units for the PV:

1. From the *Main Menu* screen, select **SETUP**.
2. Select the transmitter (e.g. “**Tx1:MSP400RH**”).
3. Select **UNITS**.
4. Select **PV Units**.
5. Follow the on-screen instructions to select and confirm the new setting. If the HART PV has no units, select and confirm the “**None**” option. (Press the **Enter** (↵) key if prompted to change mode to “**off-line**”).
6. Select “**Quit**” to exit to the previous menu.

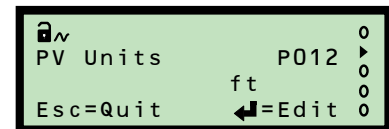

(Mobrey MCU901 Screen)

F.3.15 Scale Factor / K-Factor (P013)

Fast Keys	2, 2, 3, 4
-----------	------------

Level measurement

When the process value (PV) is a level measurement in metres, feet, or inches, this parameter converts (scales) the level measurement into alternative units before being output. Enter a value of 1.0 if alternative units are not required.

Volume measurement

When the PV is a volume measurement from a *standard non-linear-shaped* tank e.g. cylinder or sphere, use this parameter to enter the volume of the ideal shaped tank (see [Figure F-5 on page 116](#)).

When the PV is a volume measurement from a *regular-shaped* tank e.g. square or rectangular, use this parameter to enter the volume change per unit of the base unit.

When the PV is a volume measurement from an *irregular-shaped* tank, use this parameter to enter the maximum volume. See also the Special Plot section on [page 112](#) for defining the *irregular-shaped* tank.

Open channel measurement

When the PV is the flow rate in a *standard* open channel, use this parameter to enter the scale factor ('k' term) in a flow rate calculation. See "[Flow measurement](#)" on [page 116](#) for selecting a standard flow profile.

When the PV is the flow rate in an *irregular-shaped* open channel, use this parameter to enter the maximum flow rate. See also the Special Plot section on [page 116](#) for defining the *irregular-shaped* channel.

Field Communicator

To view or change the scale factor / k-factor:

- From the *Home* screen, select **2: Configure**.
- Select **2: Manual Setup**.
- Select **3: Profiling**.
- Select **4: Scale Factor P013** or **4: k-factor P013**, depending on the Non-Linear Profile selected (see [page 107](#)).
- If a change is required:
 - Input the new factor, and press "**ENTER**" to save it.
 - Press "**SEND**" to update the transmitter.

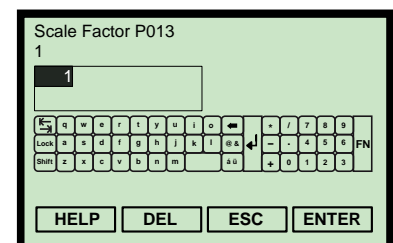

(Field Communicator Screen)

Mobrey MCU900 Series control unit

To view or change the scale factor / k-factor:

1. From the *Main Menu* screen, select **SETUP**.
2. Select the transmitter (e.g. “**Tx1:MSP400RH**”).
3. Select **DUTY**.
4. Select **PV Scale Factor**.
5. Follow the on-screen instructions to edit and save the new setting.
(Press the **Enter** (↵) key if prompted to change mode to “**off-line**”).
6. Select “**Quit**” to exit to the previous menu.

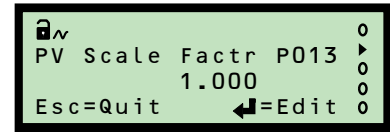

(Mobrey MCU901 Screen)

F.3.16 Profile height / Power factor (P014)

Fast Keys	2, 2, 3, 5
-----------	------------

Level measurement

This is not used for level measurements. It does not appear on the Field Communicator unless required for volume or flow measurements.

Volume measurement

When the process value (PV) is a volume measurement from a *standard non-linear-shaped* tank e.g. an ideal horizontal cylinder or a sphere, use this parameter to enter the diameter (see [Figure F-5 on page 116](#)).

When the PV is a volume measurement from a *regular-shaped* tank e.g. square or rectangular, this parameter is not used.

When the PV is a volume measurement from an *irregular-shaped* tank, use this parameter to enter the maximum height (see [page 112](#)). See also the Special Plot section on [page 112](#) for defining the *irregular-shaped* tank.

Open channel measurement

When the process value (PV) is a flow rate in a *standard* open channel, this parameter is used as the power factor ('pwr' term) in a flow rate calculation (see “[Flow measurement](#)” on [page 116](#)).

When the PV is the flow rate in an *irregular-shaped* open channel, use this parameter to enter the maximum height (see [page 112](#)). See also the Special Plot section on [page 116](#) for defining the *irregular-shaped* channel.

Field Communicator

To view or change the diameter, maximum height, or power factor:

1. From the *Home* screen, select **2: Configure**.
2. Select **2: Manual Setup**.
3. Select **3: Profiling**.
4. Select **5: Non-Linear Profile Height P014** or **5: Power Factor P014** depending on the Non-Linear Profile selected (see [page 107](#)).
5. If a change is required:
 - (a) Input a new value, and press “**ENTER**” to save it.
 - (b) Press “**SEND**” to update the transmitter.

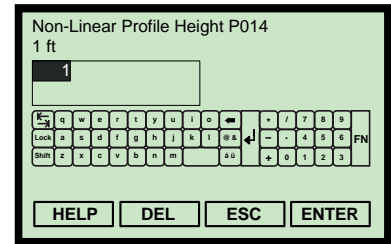

(Field Communicator Screen)

Mobrey MCU900 Series control unit

To view or change the diameter, maximum height, or power factor:

1. From the *Main Menu* screen, select **SETUP**.
2. Select the transmitter (e.g. “**Tx1:MSP400RH**”).
3. Select **DUTY**.
4. Select **Profile Height**.
5. Follow the on-screen instructions to edit and save the new setting. (Press the **Enter** (↵) key if prompted to change mode to “**off-line**”).
6. Select “**Quit**” to exit to the previous menu.

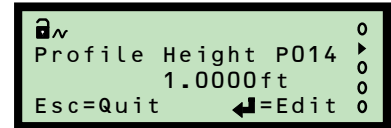

(Mobrey MCU901 Screen)

F.3.17 Profile points 1 to 10 (P030 to P039)

Fast Keys	2, 2, 3, 6
-----------	------------

These parameters are used to define an irregular-shaped profile for calculating the process value (PV) from a live level reading.

Note

- See page 112 for examples of how these parameters are used.

Field Communicator

To view or change the profile point:

- From the *Home* screen, select **2: Configure**.
- Select **2: Manual Setup**.
- Select **3: Profiling**.
- Select **6: Plot Non-Linear Profile Points**.
- Select a profile point e.g. **1: Profile Point1 P030**.
- If a change is required:
 - Input a new value, and then select “**ENTER**” to save it.
 - Press “**SEND**” to update the transmitter.

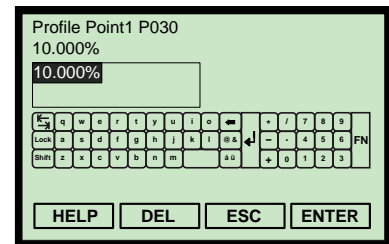

(Field Communicator Screen)

Note

- The profile point parameters are only accessible on a Field Communicator if they are required for a selected Non-linear Profile (see page 107). The points can be changed only if the “Special Plotted” profile has been selected.

Mobrey MCU900 Series control unit

To view or change the profile point:

- From the *Main Menu* screen, select **SETUP**.
- Select the transmitter (e.g. “**Tx1:MSP400RH**”).
- Select **DUTY**.
- Select **NLP CURVE**.
- Select a profile point e.g. “**Profile Pt. 1**”.
- Follow the on-screen instructions to edit and save the new setting. (Press the **Enter** (↵) key if prompted to change mode to “**off-line**”).
- Select “**Quit**” to exit to the previous menu.

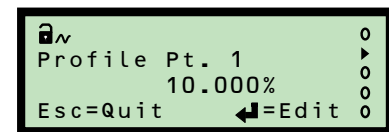

(Mobrey MCU901 Screen)

F.3.18 Upper range value (P015)

Fast Keys	2, 2, 1, 3
-----------	------------

This defines the process value (PV) represented by a 20 mA output from the transmitter. The span of the 4–20 mA current output is defined by the **Upper Range Value** parameter and the **Lower Range Value** parameter (page 126).

Consider a tank with a 120 gallons capacity. When full, a 20 mA output current is required from the transmitter. Therefore, the upper range value is set to 120 if the PV is in gallon units. The lower range value is typically set to 0 (gallons) for the 4 mA output to indicate an empty tank.

The upper range value can be less than the lower range value, in which case the current output will decrease for an increasing process value (PV).

Note

- The upper range value is *automatically overwritten* when the **Tank Shape/NLP** parameter is used to select a flume flow profile, but the populated value can still be edited if required. See Table F-1 on page 119 for the 20 mA point values.
- The displayed units are selected using the parameter **Primary Variable Units** (see page 120). Changing units does not re-scale the upper range value.

Field Communicator

To view or change the upper range value:

1. From the *Home* screen, select **2: Configure**.
2. Select **2: Manual Setup**, and then **1: Basic Setup**.
3. Select **3: Upper Range Value P015**.
4. If a change is required:
 - (a) Input a new value, and then select “**ENTER**” to save it.
 - (b) Press “**SEND**” to update the transmitter.

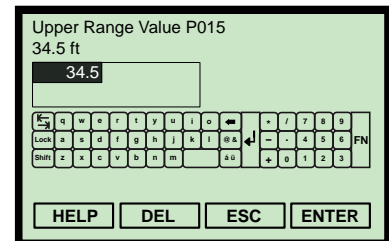

(Field Communicator Screen)

Note

- When messages appear, take appropriate action if needed and press “**OK**”.

Mobrey MCU900 Series control unit

To view or change the upper range value:

1. From the *Main Menu* screen, select **SETUP**.
2. Select the transmitter (e.g. “**Tx1: MSP400RH**”).
3. Select **OUTPUT, CURRENT**, and then **Up Range Val**.
4. Follow the on-screen instructions to edit and save the new setting. (Press the **Enter** (↵) key if prompted to change mode to “**off-line**”).
5. Select “**Quit**” to exit to the previous menu.

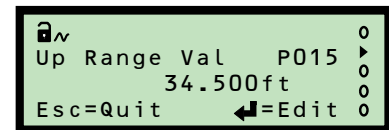

(Mobrey MCU901 Screen)

F.3.19 Lower range value (P016)

Fast Keys	2, 2, 1, 4
-----------	------------

This defines the process value (PV) represented by a 4 mA output from the transmitter. The span of the 4–20 mA current output is defined by the **Upper Range Value** parameter (page 125) and the **Lower Range Value** parameter.

Consider a tank with a 120 gallons capacity. When empty, a 4 mA output current is required from the transmitter. Therefore, the lower range value is set to 0. The upper range value is typically set to 120 (gallons) for the 20 mA output current to indicate an full tank.

The lower range value can be greater than the upper range value, in which case the current output will decrease for an increasing process value (PV).

Note

- The displayed units are selected using the parameter **Primary Variable Units** (see page 120). Changing units does not re-scale the lower range value.

Field Communicator

To view or change the lower range value:

1. From the *Home* screen, select **2: Configure**.
2. Select **2: Manual Setup**, and then **1: Basic Setup**.
3. Select **4: Lower Range Value P016**.
4. If a change is required:
 - (a) Input a new value, and then select “**ENTER**” to save it.
 - (b) Press “**SEND**” to update the transmitter.

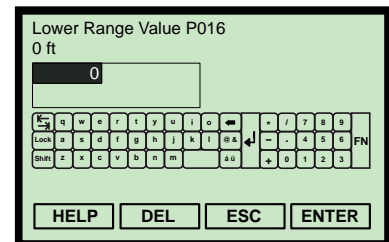

(Field Communicator Screen)

Note

- When messages appear, take appropriate action if needed and press “**OK**”.

Mobrey MCU900 Series control unit

To view or change the lower range value:

1. From the *Main Menu* screen, select **SETUP**.
2. Select the transmitter (e.g. “**Tx1:MSP400RH**”).
3. Select **OUTPUT, CURRENT**, and then **Low Range Val**.
4. Follow the on-screen instructions to input and save the new setting. (Press the **Enter** (↵) key if prompted to change mode to “**off-line**”).
5. Select “**Quit**” to exit to the previous menu.

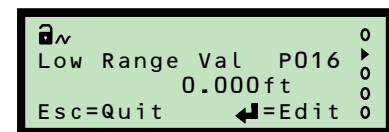

(Mobrey MCU901 Screen)

F.3.20 Damping (P020)

Fast Keys	2, 2, 1, 5
-----------	------------

The damping value is a time constant in seconds, and is applied as smoothing to the level reading and the output current.

A larger value will have the effect of smoothing out rapid changes of level, and smooth out the effects of turbulence and ripples on the liquid surface.

A value of zero can be edited, in which case no smoothing is applied and transmitter readings immediately change the output.

Note

- The pulse repetition frequency of the transmitter is one pulse per second, which means that the system response time cannot be faster than this.

Field Communicator

To view or change the damping:

1. From the *Home* screen, select **2: Configure**.
2. Select **2: Manual Setup**.
3. Select **1: Basic Setup**.
4. Select **5: Damping P020**.
5. If a change is required:
 - (a) Input a new value, and then select “**ENTER**” to save it.
 - (b) Press “**SEND**” to update the transmitter.

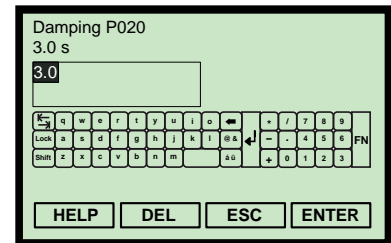

(Field Communicator Screen)

Note

- When messages appear, take appropriate action if needed and press “**OK**”.

Mobrey MCU900 Series control unit

To view or change the damping:

1. From the *Main Menu* screen, select **SETUP**.
2. Select the transmitter (e.g. “**Tx1:MSP400RH**”).
3. Select **OUTPUT, CURRENT.**, and then **Damping**.
4. Follow the on-screen instructions to edit and save the new setting. (Press the **Enter** (↵) key if prompted to change mode to “**off-line**”).
5. Select “**Quit**” to exit to the previous menu.

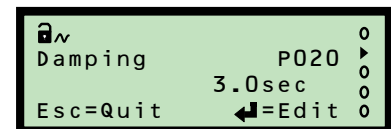

(Mobrey MCU901 Screen)

F.3.21 Setting-up relays on the MSP400RH

The MSP400RH has two integral signal relays of type SPST (Single Pole, Single Throw).

F.3.22 Relay 1 (P070 to P072)

Fast Keys	2, 2, 4, 1
-----------	------------

P070 RL1 Mode

P071 RL1 PV On Point

P072 RL1 PV Off Point

On the MSP400RH, **RL1** is factory-set to be a *control relay*. It may be set to energise at any value of PV, and de-energise at any other value of PV. The “On” point value may be greater or smaller than the “Off” point value.

All relay set-point values must be entered in the units selected for the PV.

Note

- The relay is switched off by setting the On and Off points to an identical process value.
-

F.3.23 Relay 2 (P073 to P075)

Fast Keys	2, 2, 4, 2
-----------	------------

P073 RL2 Mode

P074 RL2 PV On Point

P075 RL2 PV Off Point

On the MSP400RH, **RL2** is factory-set to be a *fault relay*. In this mode, it de-energises under Lost Echo (LE) or fault conditions. The relay de-energises if the power fails.

The mode of RL2 may be changed to control mode by entering on and off values (use RL1 instructions below). In control mode, RL2 ceases to be a fault relay until the On and Off values are reset to zero.

All relay set-point values must be entered in the units chosen for the PV.

Note

- The relay is switched off by setting the On and Off points to an identical process value.
-

F.3.24 Lost echo delay (P021)

Fast Keys	2, 2, 5 [or 6], 1
-----------	-------------------

In pulse echo level measurement systems, ultrasonic pulse echoes are sometimes lost due to adverse liquid surface conditions such as turbulence or foam. The ultrasonic pulse transmitted towards the surface is sometimes not returned, deflected away from the transmitter, or

attenuated significantly. In these conditions, the transmitter holds the last valid data and transmits another pulse to see if the echo is returned.

Lost Echo Delay (P021) defines the period that the transmitter will hold and display the present valid surface measurement, waiting to update the measurement when the echo is recovered.

A “lost echo” fault condition is signalled if the Lost Echo Delay period ends with no valid echoes returned.

A valid returned echo occurs inside a ‘window’ on either side of the liquid level. The ‘window’ increases as the range to the target increases. All echoes within the ‘window’ are monitored and averaged to smooth of the liquid level output under turbulent conditions.

Any returned echo from closer than the liquid surface is considered valid if a minimum required number of echoes (page 136) have been received. The output then changes to this new value.

Any echo returned further than the liquid surface and outside the ‘window’ is ignored. However, if a lost echo condition is developing and a period (Lost Echo Delay divided by two⁽¹⁾) has elapsed, any echoes received from further away targets are treated as valid. The liquid level measured changes to the new value after receiving four such echoes.

Field Communicator

To view or change the lost echo delay:

1. From the *Home* screen, select **2: Configure**.
2. Select **2: Manual Setup**
3. Select **5: Engineering (MSP900GH)** or **6: Engineering (MSP400RH)**.
4. Select **1: Lost Echo Delay P021**.
5. If a change is required:
 - (a) Input a new value, and then select “**ENTER**” to save it.
 - (b) Press “**SEND**” to update the transmitter.

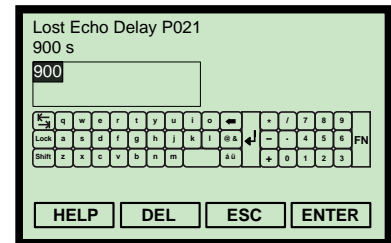

(Field Communicator Screen)

Note

- When messages appear, take appropriate action if needed and press “**OK**”.

Mobrey MCU900 Series control unit

To view or change the lost echo delay:

1. From the *Main Menu* screen, select **SETUP**.
2. Select the transmitter (e.g. “**Tx1 : MSP400RH**”).
3. Select **ENGINEERING**, and then select **LE Delay**.
4. Follow the on-screen instructions to edit and save the new setting. (Press the **Enter** (↵) key if prompted to change mode to “**off-line**”).

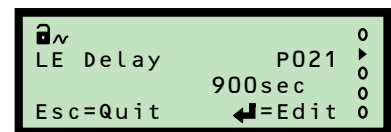

(Mobrey MCU901 Screen)

(1) Maximum of 20 seconds.

5. Select “Quit” to exit to the previous menu.

F.3.25 Lost echo action (P022)

Fast Keys	2, 2, 5 [or 6], 2
-----------	-------------------

This defines what happens to the process value (PV) and output current when a “lost echo” condition exists (see page 128).

“MINIMUM” action

The PV is forced to zero while a “lost echo” condition exists.

In addition, the two-wire loop current changes to indicate a *low* or *high* alarm as specified by the model code (see “” on page 70). The current remains at that level until the correct target echo is recovered.

“MAXIMUM” action

The PV is forced to the maximum while a “lost echo” condition exists. The maximum PV is the value that occurs when an echo is received from the transmitter face.

In addition, the two-wire loop current changes to indicate a *low* or *high* alarm as specified by the model code (see “” on page 70). The current remains at that level until the correct target echo is recovered.

“HOLD” action

The current output is held at the last good PV value.

Field Communicator

To view or change the lost echo action:

1. From the *Home* screen, select **2: Configure**.
2. Select **2: Manual Setup**.
3. Select **5: Engineering** (*MSP900GH*) or **6: Engineering** (*MSP400RH*).
4. Select **2: Lost Echo Action P022**.
5. If a change is required:
 - (a) Select a new action, and then press “ENTER” to save it.
 - (b) Press “SEND” to update the transmitter.

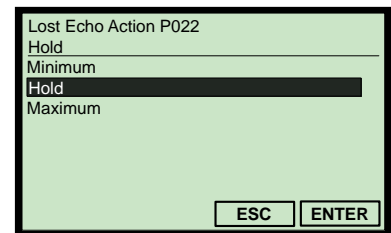

(Field Communicator Screen)

Note

- When messages appear, take appropriate action if needed and press “OK”.

Mobrey MCU900 Series control unit

To view or change the lost echo action:

1. From the *Main Menu* screen, select **SETUP**.
2. Select the transmitter (e.g. “Tx1:MSP400RH”).
3. Select **ENGINEERING**.
4. Select **LE Action**.
5. Follow the on-screen instructions to edit and save the new setting.
(Press the **Enter** (↵) key if prompted to change mode to “**off-line**”).
6. Select “**Quit**” to exit to the previous menu.

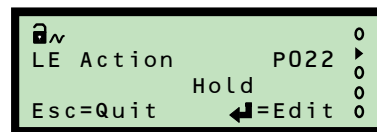

(Mobrey MCU901 Screen)

F.3.26 Speed of sound (P024)

Fast Keys	2, 2, 5 [or 6], 4
------------------	-------------------

This is for entering the speed of sound of the gas above the liquid surface (ullage gas) in a closed tank at 32 °F (0 °C) (see [Table F-2](#)).

A new speed of sound is then calculated for the ullage gas at the temperature and humidity level in the tank (see calculated **Speed of Sound** on [page 158](#)). The correction for temperature effects is made using the parameter **Temperature** ([page 132](#)) and assumes the entered Speed of Sound (P024) value is valid at 32 °F (0 °C).

For systems monitoring aqueous liquids with air (or nitrogen) as the primary gas in the ullage space, the entered Speed of Sound (P024) value should be 1088.6 ft/s (331.80 m/s). This is the most accurate setting for temperatures in the range of 32 to 104 °F (0 to 40 °C).

If the tank vapor space is filled with a different gas, a revised Speed of Sound (P024) value should be entered. Gas mixtures have speed of sound values calculated as an average according to the proportion of the gases present.

Table F-2. Speed of sound for ullage gases at 32 °F (0 °C)

Ullage Gas	Speed of Sound ft/s (m/s)	Ullage Gas	Speed of Sound ft/s (m/s)
Acetaldehyde	800.53 (244)	Ethylether	675.85 (206)
Ammonia	1361.55 (415)	Methane	1410.76 (430)
Argon	1010.50 (308)	Methanol	1099.08 (335)
Benzene	580.71 (177)	Nitrogen	1105.64 (337)
Carbon Tetrachloride	475.72 (145)	Nitric oxide	1095.80 (334)
Cyclohexane	593.83 (181)	Oxygen	1089.24 (332)
Ethane	1036.35 (316)	Propane	780.84 (238)
Ethylalcohol	846.46 (258)	Sulphur hexafluoride	436.35 (133)

Field Communicator

To view or change the speed of sound setting:

1. From the *Home* screen, select **2: Configure**.
2. Select **2: Manual Setup**.
3. Select **5: Engineering (MSP900GH)** or **6: Engineering (MSP400RH)**.
4. Select **4: Speed of Sound P024**.
5. If a change is required:
 - (a) Input a new value, and then select “**ENTER**” to save it.
 - (b) Press “**SEND**” to update the transmitter.

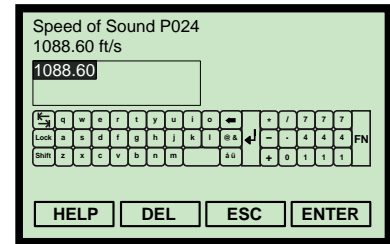

(Field Communicator Screen)

Mobrey MCU900 Series control unit

To view or change the speed of sound setting:

1. From the *Main Menu* screen, select **SETUP**.
2. Select the transmitter (e.g. “**Tx1: MSP400RH**”).
3. Select **ENGINEERING**, and then **Speed of Sound**.
4. Follow the on-screen instructions to edit and save the new setting. (Press the **Enter** (↵) key if prompted to change the mode to “off-line”).
5. Select “**Quit**” to exit to the previous menu.

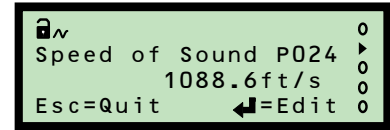

(Mobrey MCU901 Screen)

F.3.27 Temperature (P025)

Fast Keys	2, 2, 8 [or 9], 1, 5
-----------	----------------------

This is for temperature-correcting the speed of sound base value in parameter **Speed of Sound** (page 131).

For automatic (dynamic) corrections using the internal or optional remote temperature sensor, select the “**Auto**” option. The live temperature measurement is indicated in the read-only parameter **Temperature SoS Calculation** (page 158). If the sensor fails and “**Auto**” is selected, the setting reverts to 68 °F (20 °C).

Note

- The internal temperature sensor measures the air temperature at the transmitter, and not the average temperature across the ullage space. If the average temperature is known, enter this into P025. The same value is then indicated by the read-only parameter **Temperature For SoS Calculation** (page 158) and is used to correct the speed of sound.

Field Communicator

To view or change the temperature setting:

1. From the *Home* screen, select **2: Configure**.
2. Select **2: Manual Setup**.
3. Select **8: Set Temperature (MSP900GH)** or **9: Set Temperature (MSP400RH)**.
4. Select **1: Temperature**, and then **4: Set Temperature**.
5. Select **1: Set to Automatic (NaN)** for automatic (dynamic) corrections.
6. Alternatively, select **2: Edit to fix temperature**, input a temperature, and then save it by pressing “**ENTER**”.

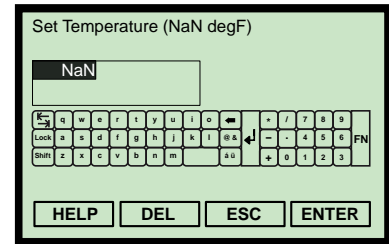

(Field Communicator Screen)

Note:

- When messages appear, take appropriate action if needed and press “OK”.
- Fast Key sequence 2, 2, 8, 1 indicates if the *internal* or *remote temperature sensor* is in use (**OFF/ON**), and if the temperature is fixed (**OFF/ON**).

Mobrey MCU900 Series Control Unit

To view or change the temperature setting:

1. From the *Main Menu* screen, select **SETUP**.
2. Select the transmitter (e.g. “**Tx1 : MSP400RH**”).
3. Select **ENGINEERING**, and then **Temperature**.
4. Follow the on-screen instructions to edit and save the new setting. (Press the **Enter** (↵) key if prompted to change mode to “**off-line**”).
5. Select “**Quit**” to exit to the previous menu.

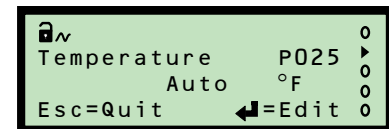

(Mobrey MCU901 Screen)

F.3.28 Set threshold (P026)

Fast Keys	2, 2, 7 [or 8], 2, 2
-----------	----------------------

This sets the sensitivity of the echo detection circuits in the transmitter. The threshold is a percentage defining the minimum signal level, above which an echo is detected and treated as a potentially valid surface or target.

When the threshold is set to “**Auto**”, the sensitivity is automatically adjusted over a range of values, depending on the echo strengths being received. The threshold is adjusted to one quarter of the peak value of the largest signal detected to give best overall performance. The live value is indicated in the read-only **Threshold In Use** parameter (page 160).

The threshold can be a constant value, which may be needed to overcome on-site difficulties or special conditions.

Note

- The threshold value can be adjusted in conjunction with parameters Upper Blanking (page 107), Lower Blanking (page 108), Threshold 1 Time (page 137), and Threshold 1 Size (page 138).

Field Communicator

To view or change the threshold setting:

1. From the *Home* screen, select **2: Configure**.
2. Select **2: Manual Setup**.
3. Select **7: Advanced Processing (MSP900GH)** or Select **8: Advanced Processing (MSP400RH)**.
4. Select **2: Threshold**.
5. Select **2: Set Threshold**.
6. Select **1: Set to Automatic (NaN)** for automatic (dynamic) adjustments.
7. Alternatively, select **2: Edit to fix threshold**, input a threshold percentage, and then save it by pressing “**ENTER**”.

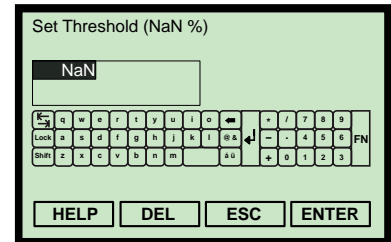

(Field Communicator Screen)

Note

- When messages appear, take appropriate action if needed and press “**OK**”.
- Fast Key sequence 2, 2, 7, [or 8], 2 indicates the status *Threshold Is Fixed (OFF/ON)* and the status *Threshold Is Not Optimum (OFF/ON)*.

Mobrey MCU900 Series control unit

To view or change the threshold setting:

1. From the *Main Menu* screen, select **SETUP**.
2. Select the transmitter (e.g. “**Tx1:MSP400RH**”).
3. Select **ENGINEERING**, and then select **Set Threshold**.
4. Follow the on-screen instructions to edit and save the new setting. (Press the **Enter** (↵) key if prompted to change mode to “**off-line**”).
5. Select “**Quit**” to exit to the previous menu.

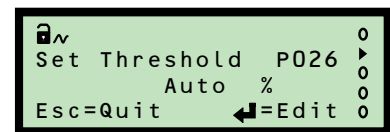

(Mobrey MCU901 Screen Shown)

F.3.29 Transmit power control (P040)

Fast Keys	2, 2, 7 [or 8], 4, 1
-----------	----------------------

The transmitted ultrasonic energy can be controlled automatically to avoid strong close echoes saturating the electronics of the transmitter. The live level is indicated in the read-only **Transmit Power** parameter (page 162).

Field Communicator

To enable or disable Transmit Power Control:

1. From the *Home* screen, select **2: Configure**.
2. Select **2: Manual Setup.**, and then
3. Select **7: Advanced Processing (MSP900GH)** or Select **8: Advanced Processing (MSP400RH)**
4. Select **4: Set Power Control**.
5. Select **1: Power Control P040**.
6. If a change is required:
 - (a) Select “Disable” or “Enable”, and then press “ENTER” to confirm it.
 - (b) Press “SEND” to update the transmitter.

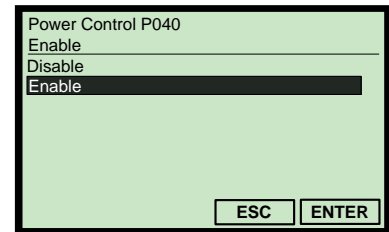

(Field Communicator Screen)

Note

- Fast Key sequence 2, 2, 7 [or 8], 4 indicates the status *Power Control Is Active (OFF/ON)* and the live **Transmit Power** level.

Mobrey MCU900 Series control unit

To enable or disable Transmit Power Control:

1. From the *Main Menu* screen, select **SETUP**.
2. Select the transmitter (e.g. “Tx1 : MSP400RH”).
3. Select **ENGINEERING**, and then select **ADVANCED**.
4. Select **Tx Pwr Control**.
5. Follow the on-screen instructions to edit and save the new setting. (Press the **Enter** (↵) key if prompted to change mode to “off-line”).
6. Select “Quit” to exit to the previous menu.

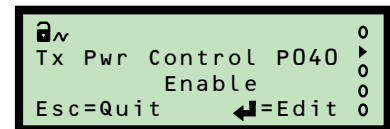

(Mobrey MCU901 Screen Shown)

F.3.30 Pulse repeat (P041)

Fast Keys	-
-----------	---

The nominal rate of repetition for ultrasonic pulses from the transmitter is one pulse per second. If two transmitters were located within the same tank, it is possible this would allow ultrasonic pulses from one unit to be received by the other. This can be prevented by having both transmitters operate with different rates of pulse repetition, which means this interference is rejected as not consistent (pulse-to-pulse). **Pulse Repeat** allows the pulse repetition interval to be adjusted by increments of 0.1 seconds.

This parameter is not available in the MSP Series DD (Device Descriptor) file.

Mobrey MCU900 Series control unit

To view or change the pulse rate:

1. From the *Main Menu* screen, select **SETUP**.
2. Select the transmitter (e.g. “Tx1:MSP400RH”).
3. Select **ENGINEERING, ADVANCED**, and then **Pulse Repeat**.
4. Follow the on-screen instructions to edit and save the new setting.
(Press the **Enter** (↵) key if prompted to change mode to “**off-line**”).
5. Select “**Quit**” to exit to the previous menu.

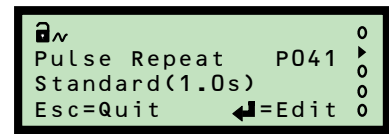

(Mobrey MCU901 Screen)

F.3.31 Echoes needed (P042)

Fast Keys	-
-----------	---

Echoes Needed is used to avoid stirrers that give occasional high level signals when they protrude from the liquid surface. The transmitter monitors the echoes returned from the liquid surface or any other target within range.

A valid surface echo is one that exceeds the signal strength threshold consecutively for more ultrasonic pulse cycles than set by **Echoes Needed**.

This parameter is not available in the MSP Series DD (Device Descriptor) file.

Mobrey MCU900 Series control unit

To view or change the number of echoes needed:

1. From the *Main Menu* screen, select **SETUP**.
2. Select the transmitter (e.g. “Tx1:MSP400RH”).
3. Select **ENGINEERING, ADVANCED**, and then **Echoes Needed**.
4. Follow the on-screen instructions to edit and save the new setting.
(Press the **Enter** (↵) key if prompted to change mode to “**off-line**”).
5. Select “**Quit**” to exit to the previous menu.

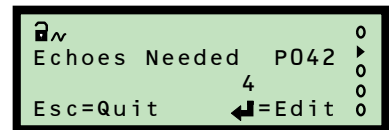

(Mobrey MCU901 Screen)

F.3.32 Threshold 1 time (P043)

Fast Keys	2, 2, 7 [or 8], 2, 6
------------------	----------------------

False echoes may occur close to the transmitter face. If they occur outside the **Upper Blanking** distance (page 131), the false echo can be ignored by entering the *echo size* as a percentage and a *time* (representing distance).

Enter the *time* (representing distance) into **Threshold 1 Time (P043)**.

For example, 6 ms represents an approximate distance of 1 m, and 2 ms represents a distance of approximately 1 ft.

See “**Threshold 1 size (P048)**” on page 138 for entering the *echo size*.

Note

- See also “**False echoes under certain ambient operating conditions**” on page 62 for additional information about adjusting the settings of parameters P043 and P048.

Field Communicator

To view or change the threshold time:

- From the *Home* screen, select **2: Configure**.
- Select **2: Manual Setup**.
- Select **7: Advanced Processing (MSP900GH)** or
Select **8: Advanced Processing (MSP400RH)**
- Select **2: Threshold**, and then **6: Threshold 1 Time P043**.
- If a change is required:
 - Input a new value, and then select “**ENTER**” to save it.
 - Press “**SEND**” to update the transmitter.

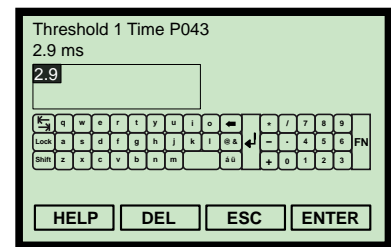

(Field Communicator Screen)

Mobrey MCU900 Series control unit

To view or change the threshold time:

- From the *Main Menu* screen, select **SETUP**.
- Select the transmitter (e.g. “**Tx1: MSP400RH**”).
- Select **ENGINEERING**, and then **ADVANCED**.
- Select **Thresh 1 Time**.
- Follow the on-screen instructions to edit and save a new setting.
- Select “**Quit**” to exit to the previous menu.

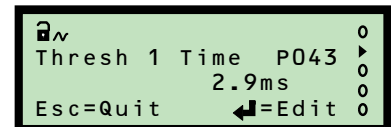

(Mobrey MCU901 Screen)

F.3.33 Threshold 1 size (P048)

Fast Keys	2, 2, 7 [or 8], 2, 7
------------------	----------------------

False echoes may occur close to the transmitter face. If they occur outside the **Upper Blanking** distance (page 131), the false echo can be ignored by entering the *echo size* as a percentage and a *time* (representing distance). The *echo size* is set by the parameter **Threshold 1 Size (P048)**.

See “Threshold 1 time (P043)” on page 137 for entering the *time* (representing distance).

Note

- Use the read-only parameter **Echo Size** (page 154) as a reference for the false echo size.
- See also “False echoes under certain ambient operating conditions” on page 62 for additional information about adjusting the settings of parameters P043 and P048.

Field Communicator

To view or change the threshold size:

1. From the *Home* screen, select **2: Configure**.
2. Select **2: Manual Setup**.
3. Select **7: Advanced Processing (MSP900GH)** or
Select **8: Advanced Processing (MSP400RH)**
4. Select **2: Threshold**.
5. Select **7: Threshold 1 Size P048**.
6. If a change is required:
 - (a) Input a new value, and then select “**ENTER**” to save it.
 - (b) Press “**SEND**” to update the transmitter.

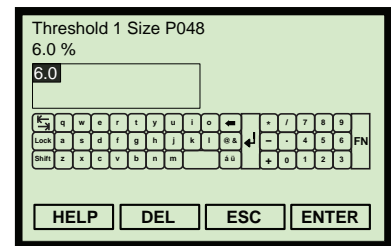

(Field Communicator Screen)

Mobrey MCU900 Series control unit

To view or change the threshold size:

1. From the *Main Menu* screen, select **SETUP**.
2. Select the transmitter (e.g. “**Tx1:MSP400RH**”).
3. Select **ENGINEERING**.
4. Select **ADVANCED**.
5. Select **Thresh 1 Size**.
6. Follow the on-screen instructions to edit and save the new setting. (Press the **Enter** (↵) key if prompted to change the mode to “off-line”).
7. Select “**Quit**” to exit to the previous menu.



(Mobrey MCU901 Screen)

F.3.34 Target pulses (P044)

Fast Keys	2, 2, 7 [or 8], 5, 1
-----------	----------------------

Target Pulses (P044) is the number of ultrasonic pulses in each burst sent from the transmitter every second.

The factory default “**Automatic**” setting allows the transmitter to decide the number of pulses. Alternatively, select a number in the range 4 to 32.

Note

- See **Pulses in Use** (page 161) for the actual number of pulses used.

Field Communicator

To view or change the number of pulses in a burst:

- From the *Home* screen, select **2: Configure**.
- Select **2: Manual Setup**.
- Select **7: Advanced Processing (MSP900GH)** or **8: Advanced Processing (MSP400RH)**
- Select **5: Set Target Pulses**.
- Select **1: Target Pulses P044**.
- If a change is required:
 - Select a new setting, and then select “**ENTER**” to save it.
 - Press “**SEND**” to update the transmitter.

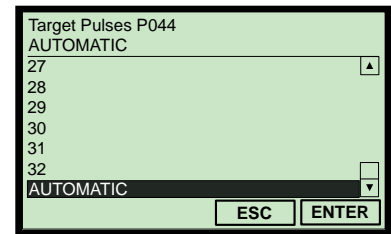

(Field Communicator Screen)

Mobrey MCU900 Series control unit

To view or change the number of pulses in a burst:

- From the *Main Menu* screen, select **SETUP**.
- Select the transmitter (e.g. “**Tx1:MSP400RH**”).
- Select **ENGINEERING**, and then **ADVANCED**.
- Select **Target Pulses**.
- Follow the on-screen instructions to edit and save the new setting. (Press the **Enter** (↵) key if prompted to change mode to “**off-line**”).
- Select “**Quit**” to exit to the previous menu.

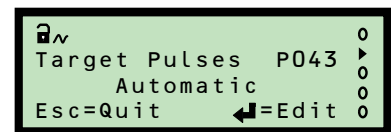

(Mobrey MCU901 Screen)

F.3.35 Target frequency (P045)

Fast Keys	2, 2, 7 [or 8], 6, 1
-----------	----------------------

This sets the frequency used for transmitting an ultrasonic pulse. The optimum frequency depends on the characteristics of the transmitter’s piezoelectric crystals, which are affected by temperature.

The transmitter has a look-up table to select a frequency value to give the highest echo strength from the prevailing conditions at the site. This look-up function operates when Target Frequency (P045) is set to “Auto”.

Site conditions sometimes require a fixed frequency. Target Frequency (P045) is used to set a fixed frequency, but the actual frequency value used is selected from the look-up table and the nearest to that entered value is selected automatically.

Note

- See **Frequency** (page 159) for the actual frequency used.

Field Communicator

To view or change the target frequency:

- From the *Home* screen, select **2: Configure**.
- Select **2: Manual Setup**.
- Select **7: Advanced Processing (MSP900GH)** or Select **8: Advanced Processing (MSP400RH)**
- Select **6: Set Frequency**, and then **1: Target Frequency P045**.
- If a change is required:
 - Select a new setting, and then select “**ENTER**” to save it.
 - Press “**SEND**” to update the transmitter.

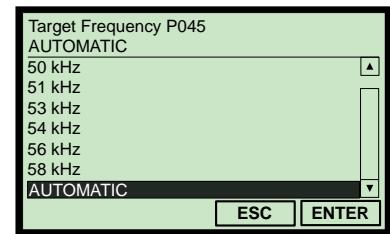

(Field Communicator Screen)

Mobrey MCU900 Series control unit

To view or change the target frequency:

- From the *Main Menu* screen, select **SETUP**.
- Select the transmitter (e.g. “**Tx1: MSP400RH**”).
- Select **ENGINEERING**.
- Select **ADVANCED**.
- Select **Target Freq**.
- Follow the on-screen instructions to edit and save the new setting. (Press the **Enter** (↵) key if prompted to change mode to “**off-line**”).
- Select “**Quit**” to exit to the previous menu.



(Mobrey MCU901 Screen)

F.3.36 Spike rejection (P049)

Fast Keys	2, 2, 7 [or 8], 3, 1
-----------	----------------------

This sets the minimum duration of a valid echo signal, and is used to reject transient electrical interference (spike) signals.

Note

- Spike rejection is switched-off when it is set to 0.

Field Communicator

To view or change the spike rejection:

1. From the *Home* screen, select **2: Configure**.
2. Select **2: Manual Setup**.
3. Select **7: Advanced Processing (MSP900GH)** or Select **8: Advanced Processing (MSP400RH)**
4. Select **3: Set Spike Reject**.
5. Select **1: Spike Reject P049**.
6. If a change is required:
 - (a) Select a new setting, and then select “**ENTER**” to save it.
 - (b) Press “**SEND**” to update the transmitter.

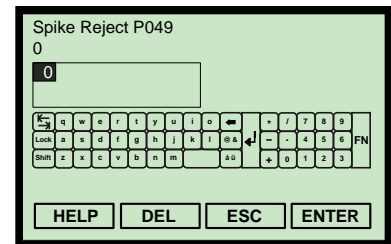

(Field Communicator Screen)

Mobrey MCU900 Series control unit

To view or change the spike rejection:

1. From the *Main Menu* screen, select **SETUP**.
2. Select the transmitter (e.g. “**Tx1:MSP400RH**”).
3. Select **ENGINEERING**.
4. Select **ADVANCED**.
5. Select **Spike Reject**.
6. Follow the on-screen instructions to edit and save the new setting. (Press the **Enter** (↵) key if prompted to change mode to “**off-line**”).
7. Select “**Quit**” to exit to the previous menu.

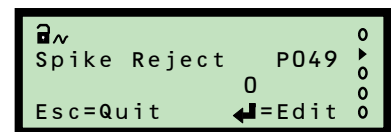

(Mobrey MCU901 Screen)

F.3.37 False echo data (P081 to P088)

Fast Keys	2, 2, 6 [or 7], 8
------------------	-------------------

These parameters are the four false echo data records, each storing a false echo as distance-to-surface (e.g. 1.7 m) and echo size (e.g. 44%). The transmitter ignores these false target echoes. See also:

- Section “Learn false echo” on page 93.
- Section “Auto tank map” on page 94.

Field Communicator

To view or change the false echo data:

1. From the *Home* screen, select **2: Configure**.
2. Select **2: Manual Setup**.
3. Select **6: False Echoes (MSP900GH)** or **7: False Echoes (MSP400RH)**.
4. Select **8: False Echo Data**.
5. Select **1 to 8** for the distance-to-surface or echo size data of a false echo record, as appropriate.
6. If a change is required:
 - (a) Select a new setting, and then select “**ENTER**” to save it.
 - (b) Press “**SEND**” to update the transmitter.

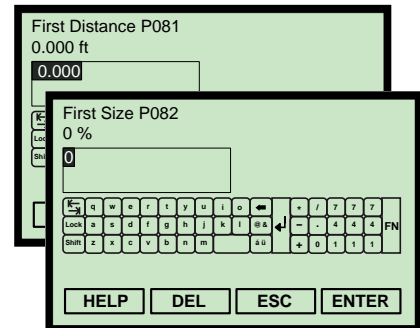

(Field Communicator Screens)

Mobrey MCU900 Series control unit

To view or change the false echo data:

1. From the *Main Menu* screen, select **SETUP**.
2. Select the transmitter (e.g. “**Tx1: MSP400RH**”).
3. Select **ENGINEERING**.
4. Select **FALSE ECHO DATA**.
5. Select a menu option for the distance-to-surface or echo size data of a false echo record, as appropriate.
6. Follow the on-screen instructions to edit and save the new setting. (Press the **Enter** (↵) key if prompted to change mode to “**off-line**”).
7. Select “**Quit**” to exit to the previous menu.

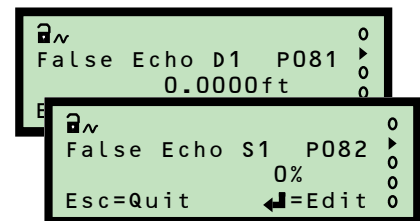

(Mobrey MCU901 Screens)

F.3.38 Clear false echoes (P089)

Fast Keys	2, 2, 6 [or 7], 5
-----------	-------------------

This is used to clear a specified False Echo Data record, or clear all of the False Echo Data records.

Field Communicator

To clear false echo data:

1. From the *Home* screen, select **2: Configure**.
2. Select **2: Manual Setup**.
3. Select **6: False Echoes** (*MSP900GH*) or **7: False Echoes** (*MSP400RH*).
4. Select **5: Clear False Echoes**.
5. Select **"All"** or a numbered false echo record, and then press **"ENTER"** to confirm the selection.
6. Press **"SEND"** to update the transmitter.

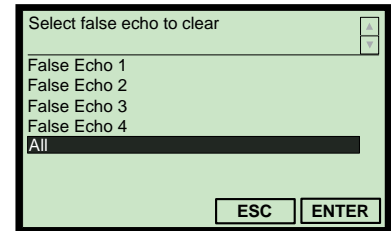

(Field Communicator Screen)

Note

- When messages appear, take appropriate action if needed and press **"OK"**.

Mobrey MCU900 Series control unit

To clear false echo data:

1. From the *Main Menu* screen, select **SETUP**.
2. Select the transmitter (e.g. **"Tx1:MSP400RH"**).
3. Select **ENGINEERING**, and then select **FALSE ECHO ACTION**.
4. Select **Clear False Echoes**.
5. Select **"Edit"** (↵), then select an option using the up-arrow or down-arrow keys, and finally select **"Save"** (↵) to confirm the selection. (Press the **Enter** (↵) key if prompted to change mode to **"off-line"**).
6. When finished, select **"Quit"** to exit to the previous menu.

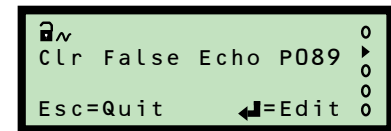

(Mobrey MCU901 Screen)

F.3.39 Transducer material (P970)

Fast Keys	1, 3, 1, 2, 1
-----------	---------------

This read-only parameter indicates the transmitter's wet-side material.

Field Communicator

1. From the *Home* screen, select **1: Overview**.
2. Select **3: Shortcuts**, and then select **1: Device Information**.
3. Select **2: Materials of Construction**.
4. Select **1: Transducer Material P970**.
5. When finished, press **EXIT** to exit to the previous menu.

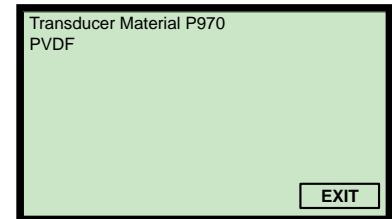

(Field Communicator Screen)

Mobrey MCU900 Series control unit

1. From the *Main Menu* screen, select **SETUP**.
2. Select the transmitter (e.g. "**Tx1 : MSP400RH**").
3. Select **SYSTEM, FIXED**, and then **Tx Material**.
4. When finished, press **EXIT** to exit to the previous menu.



(Mobrey MCU901 Screen)

F.3.40 Poll address (D951)

Fast Keys	2, 2, 4 [or 5], 2, 1
-----------	----------------------

This indicates the transmitter polling address for the HART protocol.

The poll address range is 0 to 15. When it is 0, the transmitter is in 4–20 mA mode. For all other addresses, the transmitter is in multi-drop mode and the current output is fixed to 4 mA.

Field Communicator

To view or change the poll address:

1. From the *Home* screen, select **2: Configure**.
2. Select **2: Manual Setup**.
3. Select **4: HART/Identity (MSP900GH)** or **5: HART/Identity (MSP400RH)**.
4. Select **2: Communication**, and then select **1: Poll Address D951**.
5. If a change is required:
 - (a) Select a new setting, and then select "**ENTER**" to save it.
 - (b) Press "**SEND**" to update the transmitter.

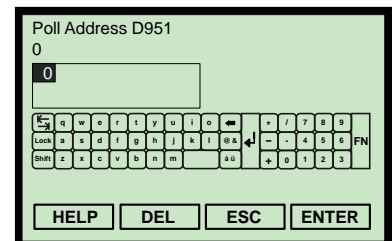

(Field Communicator Screen)

Mobrey MCU900 Series control unit

To view or change the poll address:

1. From the *Main Menu* screen, select **SETUP**.
2. Select the transmitter (e.g. “Tx1:MSP400RH”).
3. Select **SYSTEM**, and then select **FIXED**.
4. Select **HART**, and then select **Poll Address**.
5. Follow the on-screen instructions to edit and save the new setting. (Press the **Enter** (↵) key if prompted to change mode to “off-line”).
6. When finished, select “Quit” to exit to the previous menu.

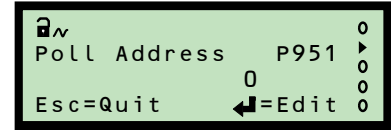

(Mobrey MCU901 Screen)

F.3.41 Maximum temperature (P046)

Fast Keys	2, 2, 8 [or 9], 3. 2
-----------	----------------------

This is a record of the maximum measured temperature.

Field Communicator

To view the maximum temperature:

1. From the *Home* screen, select **2: Configure**.
2. Select **2: Manual Setup**.
3. Select **8: Set Temperature (MSP900GH)** or **9: Set Temperature (MSP400RH)**.
4. Select **3: Internal Extremes**.
5. Select **2: Maximum Temperature P046**.

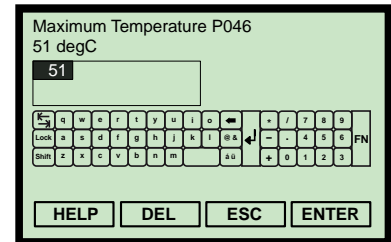

(Field Communicator Screen)

Mobrey MCU900 Series control unit

To view the maximum temperature:

1. From the *Main Menu* screen, select **MONITOR**.
2. Select the transmitter (e.g. “Tx1:MSP400RH”).
3. Select **DIAGNOSTICS**.
4. Select **HISTORY**.
5. Select **Max Temp**.
6. When finished, press **EXIT** to exit to the previous menu.

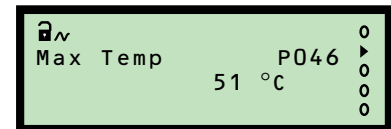

(Mobrey MCU901 Screen)

F.3.42 Minimum temperature (P047)

Fast Keys	2, 2, 8 [or 9], 3, 4
-----------	----------------------

This is a record of the lowest measured temperature.

Field Communicator

1. From the *Home* screen, select **2: Configure**.
2. Select **2: Manual Setup**.
3. Select **8: Set Temperature (MSP900GH)** or **9: Set Temperature (MSP400RH)**.
4. Select **3: Internal Extremes**, and then **4: Minimum Temperature P047**.

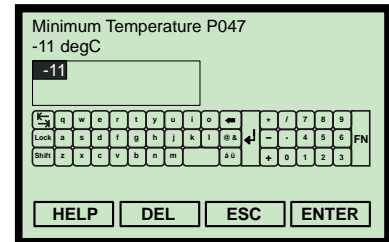

(Field Communicator Screen)

Mobrey MCU900 Series control unit

1. From the *Main Menu* screen, select **MONITOR**.
2. Select the transmitter (e.g. “Tx1:MSP400RH”).
3. Select **DIAGNOSTICS, HISTORY**, and then **Min Temp**.
4. When finished, press **EXIT** to exit to the previous menu.

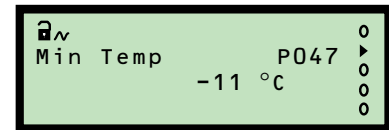

(Mobrey MCU901 Screen)

F.3.43 Date (P003)

Fast Keys	2, 2, 4 [or 5], 1, 6
-----------	----------------------

This is a record of the last date there was a change.

Field Communicator

1. From the *Home* screen, select **2: Configure**.
2. Select **2: Manual Setup**.
3. Select **4: HART/Identity (MSP900GH)** or **5: HART/Identity (MSP400RH)**.
4. Select **1: Identity**, and then **6: Date P003**.

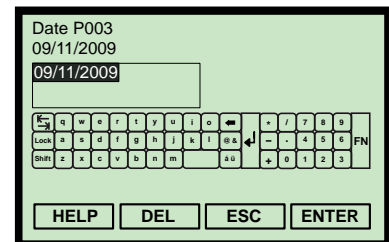

(Field Communicator Screen)

Mobrey MCU900 Series control unit

1. From the *Main Menu* screen, select **MONITOR**.
2. Select the transmitter (e.g. “Tx1:MSP400RH”).
3. Select **DIAGNOSTICS, HISTORY**, and then **Date**.
4. When finished, press **EXIT** to exit to the previous menu.

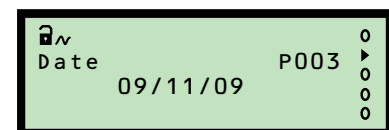

(Mobrey MCU901 Screen)

F.4 Monitoring and diagnostic parameters

Note

- For relevant menu structures, refer to Appendix [Appendix D: Mobrey MCU900 Series](#) or [Appendix E: Field Communicator](#) as appropriate for your HART Master Device.

F.4.1 Process value / Primary variable (PV) (D900)

Fast Keys	1, 2, 1
-----------	---------

This indicates the live process value that drives the 4–20 mA Current Output. In HART terminology, this parameter is the Primary Variable (PV).

The factory default is for the process value to be a level measurement in metres, feet, or inches. It can be a volume or flow measurement if the transmitter has been configured to do those calculations.

Note

- Reported units for the HART Primary Variable is selectable (see [page 120](#)).

Field Communicator

To view the live PV:

- From the *Home* screen, select **1: Overview**.
- Select **2: Primary Purpose Variables**.
- Select **1: Primary Variable D900**.
- When finished, press **EXIT** to exit to the previous menu.

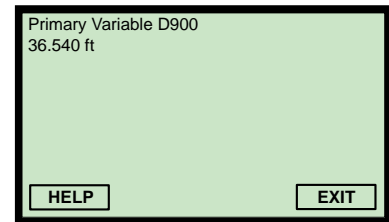

(Field Communicator Screen)

Note

- PV is available at other Fast Key sequences e.g. 3, 2, 1, 1 (see [Appendix E: Field Communicator](#)).

Mobrey MCU900 Series control unit

To view the live PV:

- From the *Main Menu* screen, select **MONITOR**.
- Select the transmitter (e.g. “**Tx1: MSP400RH**”).
- Select **READINGS**.
- Select **VARIABLES**.
- Select **Xmtr PV**.
- When finished, select “**Quit**” to exit to the previous menu.

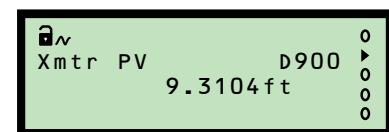

(Mobrey MCU901 Screen)

F.4.2 Level / Secondary variable (SV) (D901)

Fast Keys	1, 2, 2
-----------	---------

This indicates the live level measured by the transmitter. In HART terminology, SV is the Secondary Variable. Units are in metres, feet, or inches depending on base units (see [page 90](#)).

Note

- [Figure F-1 on page 106](#) shows this parameter in a tank geometry illustration.

Field Communicator

To view the live level measurement:

1. From the *Home* screen, select **1: Overview**.
2. Select **2: Primary Purpose Variables**.
3. Select **2: Level (SV) D901**.
4. When finished, press **EXIT** to exit to the previous menu.

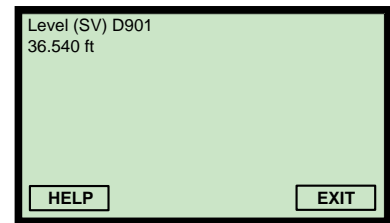

(Field Communicator Screen)

Note

- SV is also at the Fast Key sequence 3, 2, 1, 2 (see [Appendix E: Field Communicator](#)).

Mobrey MCU900 Series control unit

To view the live level measurement:

1. From the *Main Menu* screen, select **MONITOR**.
2. Select the transmitter (e.g. “Tx1:MSP400RH”).
3. Select **READINGS**, and then select **VARIABLES**.
4. Select **Level (SV)**.
5. When finished, press the **ESC** key to exit to the previous menu.

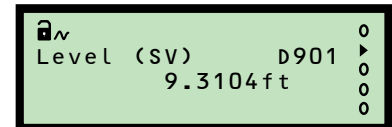

(Mobrey MCU901 Screen)

F.4.3 Distance / Tertiary variable (TV) (D902)

Fast Keys	3, 2, 1, 3
-----------	------------

This indicates the live distance-to-surface measured by the transmitter. In HART terminology, this parameter is the Tertiary Variable (TV). Units are in metres, feet, or inches, depending on base units (see [page 90](#)).

Note

- Figure F-1 on [page 106](#) shows this parameter in a tank geometry illustration.

Field Communicator

To view the live distance-to-surface measurement:

- From the *Home* screen, select **3: Service Tools**.
- Select **2: Variables**.
- Select **1: Variables**.
- Select **3: Distance (TV) D902**.
- When finished, press **EXIT** to exit to the previous menu.

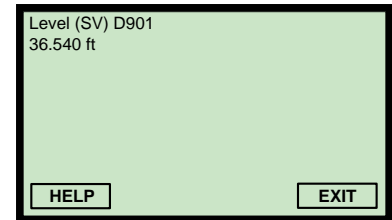

(Field Communicator Screen)

Mobrey MCU900 Series control unit

To view the live distance-to-surface measurement:

- From the *Main Menu* screen, select **MONITOR**.
- Select the transmitter (e.g. "**Tx1:MSP400RH**").
- Select **READINGS**, and then select **VARIABLES**.
- Select **Distance (TV)**.
- When finished, press the **ESC** key to exit to the previous menu.

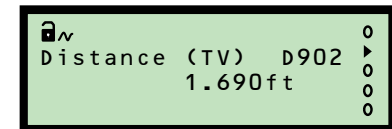

(Mobrey MCU901 Screen)

F.4.4 Temperature / Fourth variable (FV) (D903)

Fast Keys	3, 2, 1, 4
-----------	------------

This indicates the live ambient temperature measured by the transmitter. In HART terminology, this parameter is the Fourth Variable (FV). Measurement units are in °C or °F depending on **Base Units** (page 90).

Field Communicator

To view the live temperature measurement:

1. From the *Home* screen, select **3: Service Tools**.
2. Select **2: Variables**.
3. Select **1: Variables**.
4. Select **4: Transducer Temperature D903**.
5. When finished, press **EXIT** to exit to the previous menu.

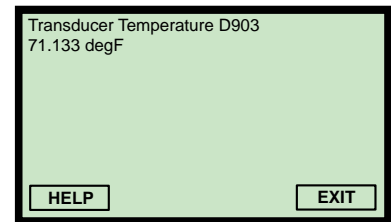

(Field Communicator Screen)

Mobrey MCU900 Series control unit

To view the live temperature measurement:

1. From the *Main Menu* screen, select **MONITOR**.
2. Select the transmitter (e.g. “Tx1:MSP400RH”).
3. Select **READINGS**.
4. Select **VARIABLES**.
5. Select **Xducer temp**.
6. When finished, press the **ESC** key to exit to the previous menu.

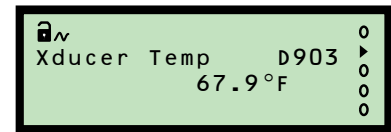

(Mobrey MCU901 Screen)

F.4.5 % of output current (D905)

Fast Keys	3, 2, 2, 3
-----------	------------

This indicates the percentage of the 4–20 mA output current in use.

- 0% represents 4 mA
- 100% represents 20 mA

Note

- When the **Poll Address** (page 163) is a non-zero number, the transmitter is in *multi-drop mode* and the current output is fixed at 4 mA. However, the read-only parameter **D905** remains active.

Field Communicator

To view the percentage of current output in use:

1. From the *Home* screen, select **3: Service Tools**.
2. Select **2: Variables**.
3. Select **2: Analog Output**.
4. Select **3: Percentage of Current Output**.
5. When finished, press the **Bksp** key to exit to the previous menu.

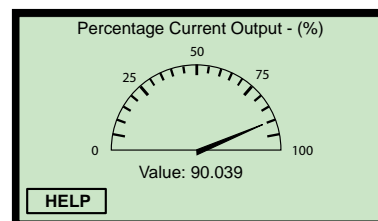

(Field Communicator Screen)

Mobrey MCU900 Series control unit

To view the percentage of current output in use:

1. From the *Main Menu* screen, select **MONITOR**.
2. Select the transmitter (e.g. “Tx1:MSP400RH”).
3. Select **READINGS**, and then select **CURRENT**.
4. Select **% of Current Output**.
5. When finished, press the **ESC** key to exit to the previous menu.

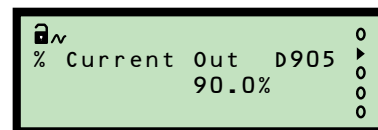

(Mobrey MCU901 Screen)

F.4.6 Current output (D906)

Fast Keys	3, 2, 2, 1
-----------	------------

This indicates the actual output current in mA.

Note

- When the **Poll Address** (page 163) is a non-zero number, the transmitter is in *multi-drop mode* and the current output is fixed at 4 mA.

Field Communicator

To view the actual output current:

- From the *Home* screen, select **3: Service Tools**.
- Select **2: Variables**.
- Select **2: Analog Output**
- Select **1: Current Output**.
- When finished, press the **Bksp** key to exit to the previous menu.

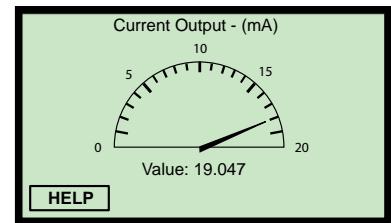

(Field Communicator Screen)

Mobrey MCU900 Series control unit

To view the actual output current:

- From the *Main Menu* screen, select **MONITOR**.
- Select the transmitter (e.g. "**Tx1: MSP400RH**").
- Select **READINGS**, and then select **CURRENT**.
- Select **Current Output**.
- When finished, press the **ESC** key to exit to the previous menu.

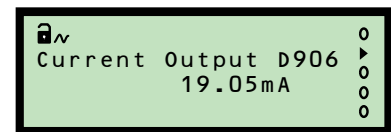

(Mobrey MCU901 Screen)

F.4.7 Distance (D910)

Fast Keys	3, 1, 2, 1, 1
-----------	---------------

This indicates the distance from the transmitter face to a detected surface.

It is a useful diagnostic because a false surface signal can be identified and related to the physical nature of the installation.

Note

- Figure F-1 on page 106 shows this parameter in a tank geometry illustration.

Field Communicator

To view the distance to a detected surface:

- From the *Home* screen, select **3: Service Tools**.
- Select **1: Alerts**.
- Select **2: Diagnostic Data**.
- Select **1: Target Data**.
- Select **1: Distance D910**.
- When finished, press **EXIT** to exit to the previous menu.

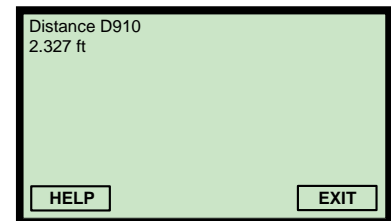

(Field Communicator Screen)

Mobrey MCU900 Series control unit

To view the distance to a detected surface:

- From the *Main Menu* screen, select **MONITOR**.
- Select the transmitter (e.g. "Tx1:MSP400RH").
- Select **DIAGNOSTICS**.
- Select **Distance**.
- When finished, press the **ESC** key to exit to the previous menu.

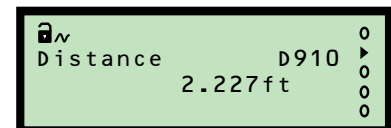

(Mobrey MCU901 Screen)

F.4.8 Echo size (D911)

Fast Keys	3, 1, 2, 1, 2
-----------	---------------

The size of the echo returned from a surface depends on the surface range, gas composition and temperature, transmitter performance, in-tank conditions (turbulence, presence of surface foam, and draughts), and other factors.

The received echo strength may vary from pulse-to-pulse but monitoring the read-only parameter Echo Size (D911) indicates the latest echo strengths.

The indicated value is an averaged percentage of the last five echoes, with 100% representing a saturated returned signal.

Field Communicator

To view the echo strength:

1. From the *Home* screen, select **3: Service Tools**.
2. Select **1: Alerts**.
3. Select **2: Diagnostic Data**.
4. Select **1: Target Data**.
5. Select **2: Echo Size D911**.
6. When finished, press **EXIT** to exit to the previous menu.

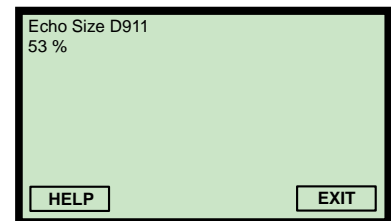

(Field Communicator Screen)

Mobrey MCU900 Series control unit

To view the echo strength:

1. From the *Main Menu* screen, select **MONITOR**.
2. Select the transmitter (e.g. "**Tx1:MSP400RH**").
3. Select **DIAGNOSTICS**.
4. Select **Echo Size**.
5. When finished, press the **ESC** key to exit to the previous menu.

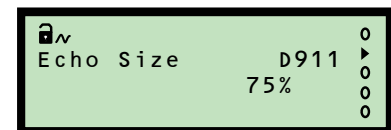

(Mobrey MCU901 Screen)

F.4.9 Echo success (D912)

Fast Keys	3, 1, 2, 1, 3
-----------	---------------

This is a measure of the quality of the echo returned. It is a percentage indicating the success rate achieved from the last ten pulse transmissions.

The success rate may fall below 100% due to the effect of extreme surface turbulence or stirrers, which might return a surface echo that is then rejected by the transmitter.

A surface echo might be rejected because it is outside the allowed 'window', set-up to establish the true liquid level. This rejects invalid readings on the principle that liquid levels do not change very quickly (see “Lost Echo Delay” on page 128).

One rejected surface echo causes Echo Success to decrease by 10%, but a subsequent valid surface echo increases the percentage by 10%. The transmitter is biased to ignore sudden liquid level changes.

Field Communicator

To view the echo success:

1. From the *Home* screen, select **3: Service Tools**.
2. Select **1: Alerts**.
3. Select **2: Diagnostic Data**.
4. Select **1: Target Data**.
5. Select **3: Success Rate D912**.
6. When finished, press **EXIT** to exit to the previous menu.

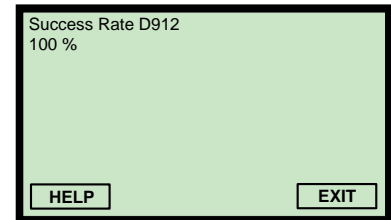

(Field Communicator Screen)

Mobrey MCU900 Series control unit

To view the echo success:

1. From the *Main Menu* screen, select **MONITOR**.
2. Select the transmitter (e.g. “Tx1:MSP400RH”).
3. Select **DIAGNOSTICS**
4. Select **Echo Success**.
5. When finished, press the **ESC** key to exit to the previous menu.



(Mobrey MCU901 Screen)

F.4.10 Target echoes (D913)

Fast Keys	3, 1, 2, 1, 4
-----------	---------------

This indicates the number of echoes detected by the transmitter. The maximum number displayed is seven.

The echo closest to the transmitter face, i.e. the highest liquid level, is used to calculate the PV (page 147). This is because the other echoes may be caused by multiple path surface reflections from the tank roof or wall.

Field Communicator

To view the number of echoes received:

1. From the *Home* screen, select **3: Service Tools**.
2. Select **1: Alerts**.
3. Select **2: Diagnostic Data**.
4. Select **1: Target Data**.
5. Select **4: Target Echoes D913**.
6. When finished, press **EXIT** to exit to the previous menu.

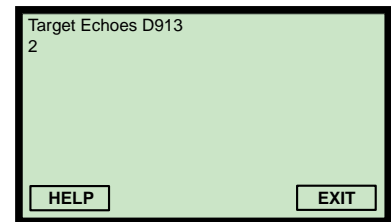

(Field Communicator Screen)

Mobrey MCU900 Series control unit

To view the number of echoes received:

1. From the *Main Menu* screen, select **MONITOR**.
2. Select the transmitter (e.g. "Tx1:MSP400RH").
3. Select **DIAGNOSTICS**.
4. Select **Target Echoes**.
5. When finished, press the **ESC** key to exit to the previous menu.

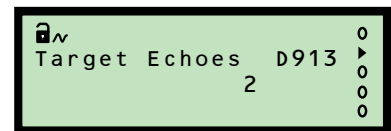

(Mobrey MCU901 Screen)

F.4.11 Speed of sound (D914)

Fast Keys	3, 1, 2, 2, 1
-----------	---------------

This indicates the temperature-corrected speed of sound calculated by the transmitter. It relates the returned echo time delay to a distance. The value is calculated using the **Temperature SoS Calc** value (page 158) and the base value entered into configuration parameter **Speed of Sound** (page 131).

Field Communicator

To view the calculated speed of sound:

1. From the *Home* screen, select **3: Service Tools**.
2. Select **1: Alerts**.
3. Select **2: Diagnostic Data**.
4. Select **2: Speed of Sound Data**.
5. Select **1: Speed of Sound D914**.
6. When finished, press “**EXIT**” to return to the previous menu.

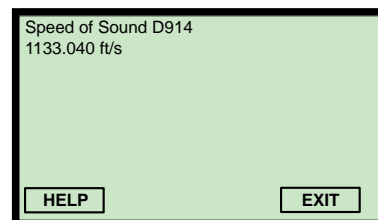

(Field Communicator Screen)

Mobrey MCU900 Series control unit

To view the calculated speed of sound:

1. From the *Main Menu* screen, select **MONITOR**.
2. Select the transmitter (e.g. “**Tx1:MSP400RH**”).
3. Select **DIAGNOSTICS**.
4. Select **Speed of Sound**.
5. When finished, press the **ESC** key to exit to the previous menu.

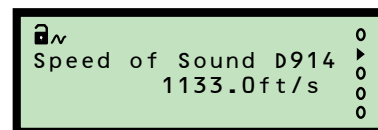

(Mobrey MCU901 Screen)

F.4.12 Temperature for SoS calculation (D915)

Fast Keys	3, 1, 2, 2, 2
-----------	---------------

This indicates the temperature used in calculating the temperature-corrected speed of sound (see above). The temperature may be a live or fixed value depending on the configuration of the parameter **Temperature** (page 132).

Note

- The live temperature is always indicated in the read-only parameter **Temperature / Fourth Variable (FV)** (page 150).

Field Communicator

To view the temperature used for calculating the speed of sound:

1. From the *Home* screen, select **3: Service Tools**.
2. Select **1: Alerts**.
3. Select **2: Diagnostic Data**.
4. Select **2: Speed of Sound Data**.
5. Select **2: Temperature for Calculation D915**.
6. When finished, press **EXIT** to exit to the previous menu.

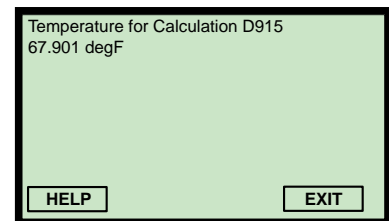

(Field Communicator Screen)

Note

- This is also at the Fast Key sequence 2, 2, 8 [or 9], 1, 6 (see Appendix E: Field Communicator).

Mobrey MCU900 Series control unit

To view the temperature used for calculating the speed of sound:

1. From the *Main Menu* screen, select **MONITOR**.
2. Select the transmitter (e.g. "**Tx1:MSP400RH**").
3. Select **DIAGNOSTICS**.
4. Select **Temp SoS Calc**.
5. When finished, press the **ESC** key to exit to the previous menu.

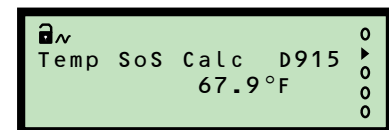

(Mobrey MCU901 Screen)

Note

- Units are in °C or °F depending on the base units selected (see page 90).

F.4.13 Frequency (D916)

Fast Keys	3, 1, 2, 3, 1
-----------	---------------

This indicates the transmitter’s actual operating frequency.

The factory default setting is to automatically set the operating frequency for optimum performance (see **Target Frequency** on page 140).

Field Communicator

To view the actual operating frequency:

1. From the *Home* screen, select **3: Service Tools**.
2. Select **1: Alerts**.
3. Select **2: Diagnostic Data**.
4. Select **3: Operation**.
5. Select **1: Transducer Frequency D916**.
6. When finished, press **EXIT** to exit to the previous menu.

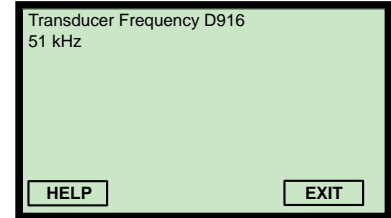

(Field Communicator Screen)

Note

- This is also at the Fast Key sequence 2, 2, 7 [or 8], 6, 2 (see Appendix E: Field Communicator).

Mobrey MCU900 Series control unit

To view the actual operating frequency:

1. From the *Main Menu* screen, select **MONITOR**.
2. Select the transmitter (e.g. “Tx1 : MSP400RH”).
3. Select **DIAGNOSTICS**.
4. Select **OPERATION**.
5. Select **Xducer Freq**.
6. When finished, press the **ESC** key to exit to the previous menu.

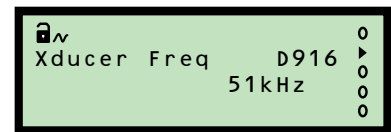

(Mobrey MCU901 Screen)

F.4.14 Threshold in use (D917)

Fast Keys	3, 1, 2, 3, 2
-----------	---------------

This indicates the echo strength threshold limit, below which echoes are rejected. The factory default setting is to automatically set the threshold level for optimum performance (see **Set Threshold** on [page 133](#)).

Field Communicator

To view the threshold limit:

1. From the *Home* screen, select **3: Service Tools**.
2. Select **1: Alerts**.
3. Select **2: Diagnostic Data**.
4. Select **3: Operation**.
5. Select **2: Threshold In Use D917**.
6. When finished, press **EXIT** to exit to the previous menu.

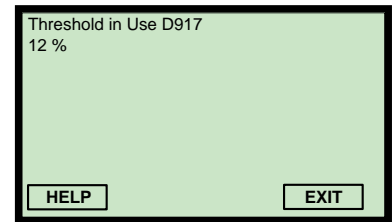

(Field Communicator Screen)

Note

- This is also at the Fast Key sequence 2, 2, 7 [or 8], 2, 4 (see [Appendix E: Field Communicator](#)).

Mobrey MCU900 Series control unit

To view the threshold limit:

1. From the *Main Menu* screen, select **MONITOR**.
2. Select the transmitter (e.g. "Tx1:MSP400RH").
3. Select **DIAGNOSTICS**.
4. Select **OPERATION**.
5. Select **Thresh In Use**.
6. When finished, press the **ESC** key to exit to the previous menu.

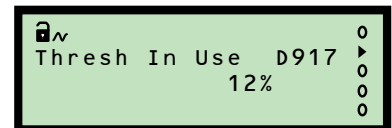

(Mobrey MCU901 Screen)

F.4.15 Pulses in use (D918)

Fast Keys	3, 1, 2, 3, 3
-----------	---------------

This is the actual number of pulses transmitted in the previous burst of pulses.

Note

- The factory default setting is to automatically decide the number of pulses in a burst for optimum performance (see **Target Pulses** on [page 139](#))

Field Communicator

To view the number of pulses being used in a burst:

1. From the *Home* screen, select **3: Service Tools**.
2. Select **1: Alerts**.
3. Select **2: Diagnostic Data**.
4. Select **3: Operation**.
5. Select **3: Pulses In Use D918**.
6. When finished, press **EXIT** to exit to the previous menu.

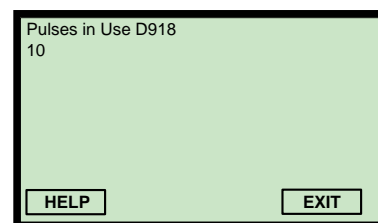

(Field Communicator Screen)

Note

- This is also at the Fast Key sequence 2, 2, 7 [or 8], 5, 2 (see [Appendix E: Field Communicator](#)).

Mobrey MCU900 Series control unit

To view the number of pulses being used in a burst:

1. From the *Main Menu* screen, select **MONITOR**.
2. Select the transmitter (e.g. "**Tx1:MSP400RH**").
3. Select **DIAGNOSTICS**.
4. Select **OPERATION**.
5. Select **Pulses In Use**.
6. When finished, press the **ESC** key to exit to the previous menu.

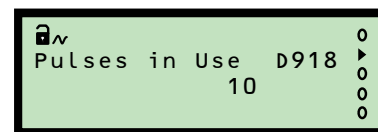

(Mobrey MCU901 Screen)

F.4.16 Transmit power (D919)

Fast Keys	3, 1, 2, 3, 4
-----------	---------------

This indicates the level of power in use for ultrasonic pulse transmission.

- The lower the level number, the less power is being used
- The higher the level number, the more power being used

Note

- The factory default setting is to optimize the power needed for ultrasonic pulse transmission (see **Transmit Power Control** on [page 135](#)).

Field Communicator

To view the pulse transmission power in use:

1. From the *Home* screen, select **3: Service Tools**.
2. Select **1: Alerts**.
3. Select **2: Diagnostic Data**.
4. Select **3: Operation**.
5. Select **4: Transmit Power D919**.
6. When finished, press **EXIT** to exit to the previous menu.

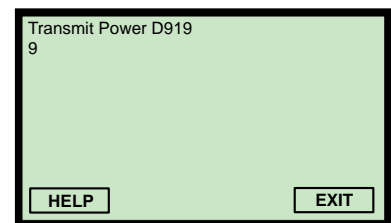

(Field Communicator Screen)

Note

- This is also at the Fast Key sequence 2, 2, 7 [or 8], 4, 3 (see [Appendix E: Field Communicator](#)).

Mobrey MCU900 Series control unit

To view the pulse transmission power in use:

1. From the *Main Menu* screen, select **MONITOR**.
2. Select the transmitter (e.g. “Tx1:MSP400RH”).
3. Select **DIAGNOSTICS**.
4. Select **OPERATION**.
5. Select **Transmit Power**.
6. When finished, press the **ESC** key to exit to the previous menu.

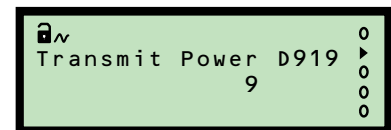

(Mobrey MCU901 Screen)

F.4.17 Model code (D949)

Fast Keys	1, 3, 1, 1, 1, 2
-----------	------------------

Field Communicator

To view the transmitter model code:

1. From the *Home* screen, select **1: Overview**.
2. Select **3: Shortcuts**.
3. Select **1: Device Information** *twice*.
4. Select **1: Identification**, and then **2: Model Code D949**.
5. When finished, press **EXIT** to exit to the previous menu.

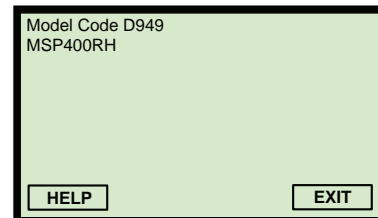

(Field Communicator Screen)

Note

- This is also at the Fast Key sequence 2, 2, 4 [or 5], 1, 5 (see [Appendix E: Field Communicator](#)).

Mobrey MCU900 Series control unit

To view the transmitter model code:

1. From the *Main Menu* screen, select **SETUP**.
2. Select the transmitter (e.g. "**Tx1: MSP400RH**").
3. Select **SYSTEM, FIXED, HART**, and then **Model Code**.
4. When finished, press the **ESC** key to exit to the previous menu.

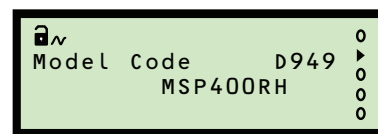

(Mobrey MCU901 Screen)

F.4.18 Hardware rev. (D952)

Fast Keys	1, 3, 1, 1, 1, 7
-----------	------------------

This is the overall hardware revision number of at time of manufacture.

Field Communicator

To view the hardware revision number:

1. From the *Home* screen, select **1: Overview**.
2. Select **3: Shortcuts**.
3. Select **1: Device Information** (*twice*).
4. Select **1: Identification**, and then **7: Hardware Revision D952**.
5. When finished, press **EXIT** to exit to the previous menu.

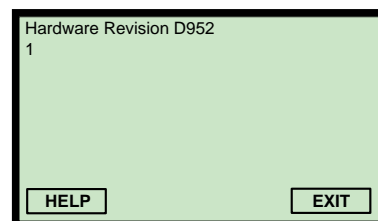

(Field Communicator Screen)

Mobrey MCU900 Series control unit

To view the hardware revision number:

1. From the *Main Menu* screen, select **SETUP**.
2. Select the transmitter (e.g. “Tx1:MSP400RH”).
3. Select **SYSTEM, FIXED, HART**, and then **Hardware Rev.**
4. When finished, press the **ESC** key to exit to the previous menu.

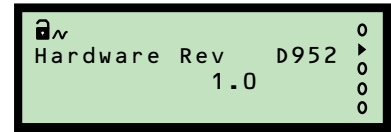

(Mobrey MCU901 Screen)

F.4.19 Software revision (D953)

Fast Keys	1, 3, 1, 1, 1, 6
-----------	------------------

This is the embedded software revision number at time of manufacture.

Field Communicator

To view the software revision number:

1. From the *Home* screen, select **1: Overview**.
2. Select **3: Shortcuts**.
3. Select **1: Device Information** (*twice*).
4. Select **1: Identification**.
5. Select **6: Software Revision D953**.
6. When finished, press **EXIT** to exit to the previous menu.

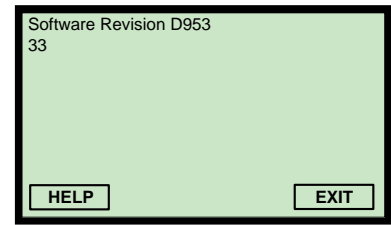

(Field Communicator Screen)

Mobrey MCU900 Series control unit

To view the software revision number:

1. From the *Main Menu* screen, select **SETUP**.
2. Select the transmitter (e.g. “Tx1:MSP400RH”).
3. Select **SYSTEM, FIXED, HART**, and then **Software Rev.**
4. When finished, press the **ESC** key to exit to the previous menu.

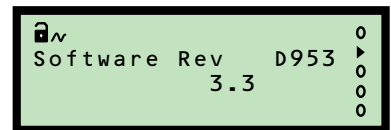

(Mobrey MCU901 Screen)

F.4.20 Manufacturer (D960)

Fast Keys	2, 2, 4 [or 5], 1, 4
-----------	----------------------

Field Communicator

To view the manufacturer name:

1. From the *Home* screen, select **2: Configure**.
2. Select **2: Manual Setup**.
3. Select **4: HART/Identity (MSP900GH)** or **5: HART/Identity (MSP400RH)**.
4. Select **1: Identity**, and then **4: Manufacturer D960**.
5. When finished, press **EXIT** to exit to the previous menu.

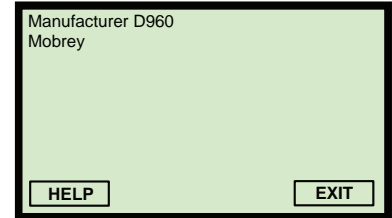

(Field Communicator Screen)

Mobrey MCU900 Series control unit

To view the manufacturer name:

1. From the *Main Menu* screen, select **SETUP**.
2. Select the transmitter (e.g. "**Tx1 : MSP400RH**").
3. Select **SYSTEM, FIXED, HART**, and then **Manufacturer**.
4. When finished, press the **ESC** key to exit to the previous menu.

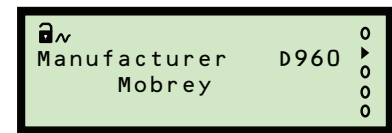

(Mobrey MCU901 Screen)

F.4.21 Unique device ID (D961)

Fast Keys	2, 2, 4 [or 5], 1, 7
-----------	----------------------

This is a factory set unique device identification number and is used by the HART protocol. It is typically the same as the **Serial Number** (page 104).

Field Communicator

To view the device identification number:

1. From the *Home* screen, select **2: Configure**.
2. Select **2: Manual Setup**.
3. Select **4: HART/Identity (MSP900GH)** or **5: HART/Identity (MSP400RH)**.
4. Select **1: Identity**, and then **7: Device ID D961**.
5. When finished, press **EXIT** to exit to the previous menu.

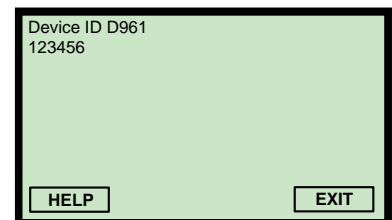

(Field Communicator Screen)

Mobrey MCU900 Series control unit

To view the device identification number:

1. From the *Main Menu* screen, select **SETUP**.
2. Select the transmitter (e.g. “Tx1: MSP400RH”).
3. Select **SYSTEM, FIXED, HART**, and then **Unique ID**.
4. When finished, press the **ESC** key to exit to the previous menu.

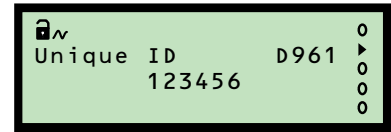

(Mobrey MCU901 Screen)

F.4.22 HART revision (D962)

Fast Keys	1, 3, 1, 1, 1, 4
-----------	------------------

This is the major revision number of the standard used for the HART communications protocol.

Field Communicator

To view the HART revision number:

1. From the *Home* screen, select **1: Overview**.
2. Select **3: Shortcuts**.
3. Select **1: Device Information** (*twice*).
4. Select **1: Identification**.
5. Select **4: HART Revision D962**.
6. When finished, press **EXIT** to exit to the previous menu.

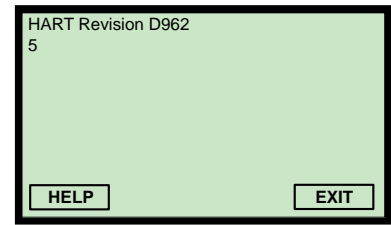

(Field Communicator Screen)

Mobrey MCU900 Series control unit

To view the HART revision number:

1. From the *Main Menu* screen, select **SETUP**.
2. Select the transmitter (e.g. “Tx1: MSP400RH”).
3. Select **SYSTEM, FIXED, HART**, and then **HART Rev**.
4. When finished, press the **ESC** key to exit to the previous menu.

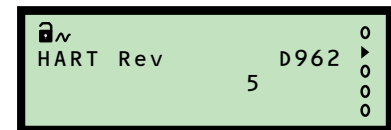

(Mobrey MCU901 Screen)

F.4.23 Transmitter specific command rev. (D963)

Fast Keys	1, 3, 1, 1, 1, 5
-----------	------------------

The revision number of specific (non-standard) HART commands supported by the transmitter.

Field Communicator

To view the revision number:

1. From the *Home* screen, select **1: Overview**.
2. Select **3: Shortcuts**.
3. Select **1: Device Information** (*twice*).
4. Select **1: Identification**, and then **5: Device Revision D963**.
5. When finished, press **EXIT** to exit to the previous menu.

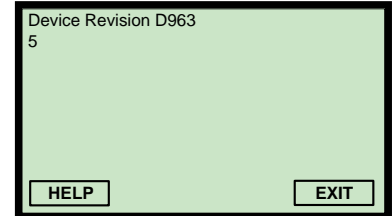

(Field Communicator Screen)

Mobrey MCU900 Series control unit

To view the revision number:

1. From the *Main Menu* screen, select **SETUP**.
2. Select the transmitter (e.g. "**Tx1: MSP400RH**").
3. Select **SYSTEM, FIXED, HART**, and then **Field Dev Rev**.
4. When finished, press the **ESC** key to exit to the previous menu.



(Mobrey MCU901 Screen)

F.4.24 Preambles (D964)

Fast Keys	2, 2, 4 [or 5], 2, 2
-----------	----------------------

This is read by a HART Master Device e.g. a Mobrey MCU900 Series control unit to determine how many preamble bytes are to be sent with each HART protocol message.

Field Communicator

To view the number of preamble bytes:

1. From the *Home* screen, select **2: Configure**.
2. Select **2: Manual Setup**.
3. Select **4: HART/Identity (MSP900GH)** or **5: HART/Identity (MSP400RH)**.
4. Select **2: Communication**, and then **2: Preambles D964**.
5. When finished, press **EXIT** to exit to the previous menu.

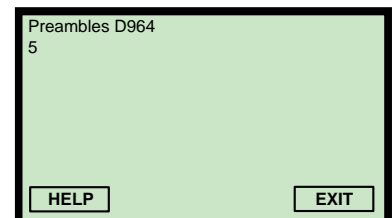

(Field Communicator Screen)

Mobrey MCU900 Series control unit

To view the number of preamble bytes:

1. From the *Main Menu* screen, select **SETUP**.
2. Select the transmitter (e.g. “Tx1:MSP400RH”).
3. Select **SYSTEM, FIXED, HART**, and then **Num Req Preams**.
4. When finished, press the **ESC** key to exit to the previous menu.

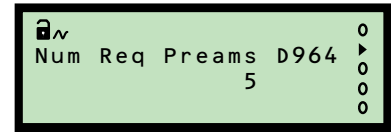

(Mobrey MCU901 Screen)

F.4.25 Transmitter flags (D965)

Fast Keys	-
-----------	---

These flags (8 digits) are used by the HART protocol.

Field Communicator

This parameter is not available in the MSP Series DD (Device Descriptor) file.

Mobrey MCU900 Series control unit

To view the flags:

1. From the *Main Menu* screen, select **SETUP**.
2. Select the transmitter (e.g. “Tx1:MSP400RH”).
3. Select **SYSTEM, FIXED, HART**, and then **Flags**.
4. When finished, press the **ESC** key to exit to the previous menu.

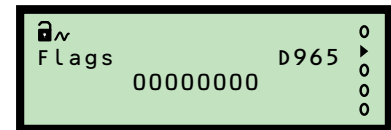

(Mobrey MCU901 Screen)

F.4.26 Primary variable trend

Fast Keys	3, 3, 1, 1
-----------	------------

This indicates the history of PV changes.

Note

- The live PV is always indicated in the read-only parameter **Process Value / Primary Variable (PV)** (page 147).

Field Communicator

To view the trend:

1. From the *Home* screen, select **3: Service Tools**.
2. Select **3: Trends**.
3. Select **1: Primary Variable** (*twice*).
4. When finished, press **EXIT** to exit to the previous menu.

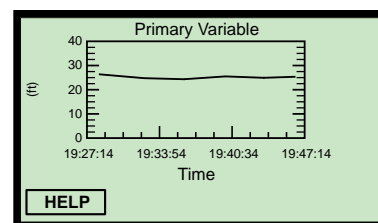

(Field Communicator Screen)

Note

- Units are the selected PV Units (see page 120).

Mobrey MSU900 Series control unit

This feature is only available on the Field Communicator and AMS.

**Emerson Process Management
Rosemount Measurement Ltd.**

158 Edinburgh Avenue
Slough, Berks, SL1 4UE, UK
Tel: +44 (0)1753 756600
Fax: +44 (0)1753 823589
www.emersonprocess.com

**Emerson Process Management
Rosemount Inc.**

8200 Market Boulevard
Chanhassen, MN 55317, USA
Tel (USA) 1 800 999 9307
Tel (International) +1 952 906 8888
Fax +1 952 906 8889

*Standard Terms and Conditions of Sale can be found at www.rosemount.com/terms_of_sale
The Emerson logo is a trademark and service mark of Emerson Electric Co.
Rosemount and the Rosemount logotype are registered trademarks of Rosemount Inc.
Mobrey and the Mobrey logotype are registered trademarks of Rosemount Measurement Ltd.
HART is a registered trademark of the HART Communication Foundation.
All other marks are the property of their respective owners.*

© 2014 Rosemount Measurement Ltd. All rights reserved.

mobrey

